



Architettura Sonora



High performing audio solution and design driven innovation, inspired by Nature

Preisliste - Liste des Prix | 1/2016 1. Januar 2016











Preise in Schweizer Franken, inkl. MWST
Prix en Franc Suisse, inclus TVA

B&W Group (Schweiz) GmbH | Ifangstarsse 5 | 8952 Schlieren
043 433 61 50 | info@bwgroup.ch | www.bwgroup.ch

TABLE OF CONTENTS

Short Cylinder	pag. 1
Medium Cylinder	pag. 3
Tall Cylinder	pag. 5
Pair Pack Solution	pag. 7
Sphere_360	pag. 9
Sphere_470	pag. 11
Cubo_400	pag. 13
Block_360	pag. 15
Pergola	pag. 16
Big Yoyo	pag. 17
Apollo	pag. 18
Suspended Modules	pag. 19
Amplifiers	pag. 22
Kit	pag. 23
Basic Stones Palette	pag. 24
Premium Stones Palette	pag. 25
Raw Collection	pag. 25
Concrete Collection	pag. 25



LEGEND

ACOUSTIC VERSION		
	FULL RANGE ACOUSTIC EMISSION	The module/s is feasible in the Full Range speaker version
	SUBWOOFER ACOUSTIC EMISSION	The module/s is feasible in the Subwoofer speaker version
SPEAKER POWER		
	SPEAKER PEAK POWER	Maximum amount of instantaneous power supported by module
AVAILABILITY INDICATION		
	STANDARD AVAILABILITY	The module belongs to the Standard Availability category
	CUSTOM AVAILABILITY	The module belongs to the Custom Availability category
ENVIRONMENTAL USE		
	OUTDOOR CERTIFIED	The module is certified for outdoor environments
TECHNICAL INDICATIONS		
	SUBWOOFER NEEDED	The employment of an external subwoofer is mandatory
	SUBWOOFER RECCOMENDED	The employment if and external subwoofer is strictly recommended
	DSP REQUIRED	The module necessarily requires employment of a DSP
SUPPLIED EQUIPMENT		
	EXTERNAL CROSSOVER SUPPLIED	The module is supplied together with an external Crossover (boxed)



SHORT CYLINDER



REF CODE		S	VP CHF
SHCY-TC	 <p>Short CYLINDER_Terracotta Impruneta Aluminium painted graphite base</p>		1'500
SHCY-ST	 <p>Short CYLINDER_Basic Stones Aluminium painted graphite base See variations on basic stones palette (pag 24)</p>	C 	2'750
SHCY-PM	 <p>Short CYLINDER_Premium Stones Aluminium painted graphite base See variations on premium stones palette (pag 25)</p>	C 	TBA

ALL ABOVE MENTIONED MODELS ARE PRICED CONSIDERING THE FOLLOWING FEATURES

Universal vertical output is suitable for both indoor & outdoor when cable arrives horizontally or underground. Gland option is strictly recommended in outdoor underground installations.
See "Customization"

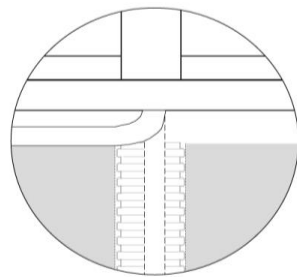

Universal cable output with rubber-feet (suitable for both indoor and outdoor)

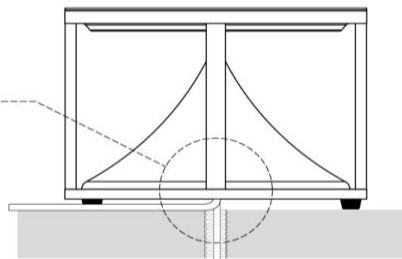





CUSTOMIZATION & ACCESSORIES

Please note that price for all optionals and accessories has to be added to the main model price

SUBWOOFER VERSION

Ref Code		VP CHF
SUB-VER	 Subwoofer Version	

BASE OPTIONALS

Ref Code		VP CHF
CYBS-SLV	 Aluminium painted silver base	125
CYBS-RAL	 Aluminium painted other RAL base	TBA
CYBS-INX	 Stainless Steel 316L base (polish, satin or gunmetal finishing)	1'550
CYBS-BRS	 Brass base	TBA
CYBS-HIFI	Hi-Fi Push Button - Only for Aluminium version (see below)	75
VH-VER	Gland option (see below)	75

ACCESSORIES

Ref Code		VP CHF
PLAST220	Plaster treatment for travertines	280
AF-VER	Anti-theft for grass land*	125
SP-VER	Sand proof system	270
COVER	PVC cover	380



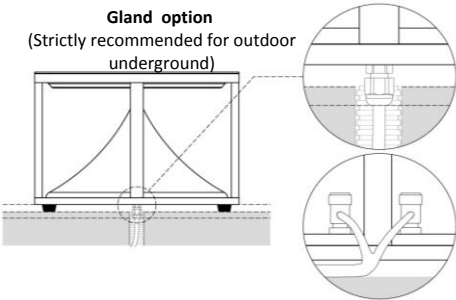
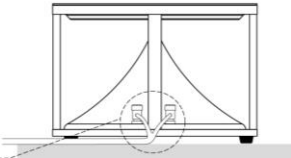





* Hard floor Anti-theft system is also available (info on request)

<p>Gland option (available for all bases) is strictly recommended for outdoor installations when cables run underground and the gland (higher than the rubber-feet) can be insert into the cable hole.</p>	<p>Gland option (Strictly recommended for outdoor underground)</p> 	<p>Hi-Fi Push Button (Only for indoor) Only for aluminium version</p> 	<p>Hi-Fi Push Button (available only for indoor installations) is suitable for a simple and easier way to connect the module.</p>
--	---	---	---



MEDIUM CYLINDER



REF CODE				VP CHF
MDCY-CN		Medium CYLINDER_Concrete Aluminium painted graphite base See variations on concrete palette (pag 25)	S 	1'500
MDCY-SS		Medium CYLINDER_Solid Surface Betacryl only white Aluminium painted graphite base	S 	2'150
MDCY-ST		Medium CYLINDER_Basic Stones Aluminium painted graphite base See variations on basic stones palette (pag 24)	C 	2'900
MDCY-PM		Medium CYLINDER_Premium Stones Aluminium painted graphite base See variations on premium stones palette (pag 25)	C 	TBA

ALL ABOVE MENTIONED MODELS ARE PRICED CONSIDERING THE FOLLOWING FEATURES

Universal vertical output is suitable for both indoor & outdoor when cable arrives horizontally or underground. Gland option is strictly recommended in outdoor underground installations. See "Customization"

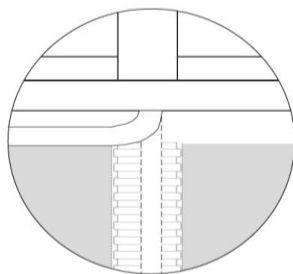

Universal cable output with rubber-feet (suitable for both indoor and outdoor)

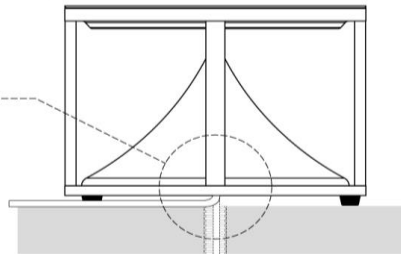





CUSTOMIZATION & ACCESSORIES

Please note that price for all optionals and accessories has to be added to the main model price

SUBWOOFER VERSION

Ref Code		VP CHF
SUB-VER	 Subwoofer Version	

BASE OPTIONALS

Ref Code		VP CHF
CYBS-SLV	 Aluminium painted silver base	125
CYBS-RAL	 Aluminium painted other RAL base	TBA
CYBS-INX	 Stainless Steel 316L base (polish, satin or gunmetal finishing)	1'550
CYBS-BRS	 Brass Base	TBA
CYBS-HIFI	Hi-Fi Push Button - Only for Aluminium version (see below)	75
VH-VER	Gland option (see below)	75

ACCESSORIES

Ref Code		VP CHF
PLAST220	Plaster treatment for travertines	280
AF-VER	Anti-theft for grass land*	125
SP-VER	Sand proof system	275
COVER	PVC cover	380

* Hard floor Anti-theft system is also available (info on request)

OUTPUT CABLE OPTIONS

Gland option
(available for all bases) is strictly recommended for outdoor installations when cables run underground and the gland (higher than the rubber-feet) can be insert into the cable hole.

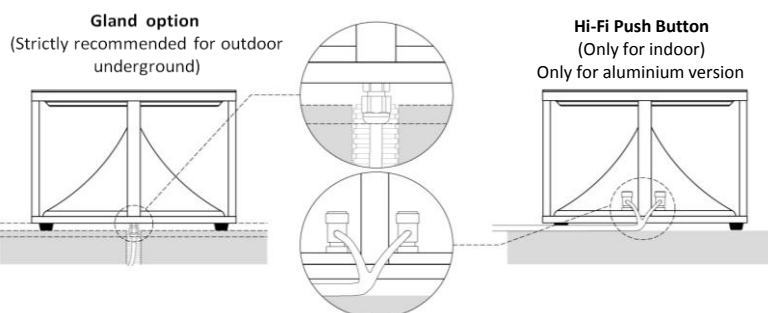

Hi-Fi Push Button
(available only for indoor installations) is suitable for a simple and easier way to connect the module.

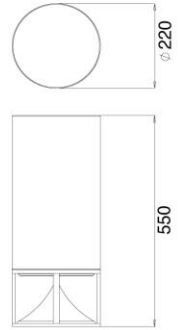
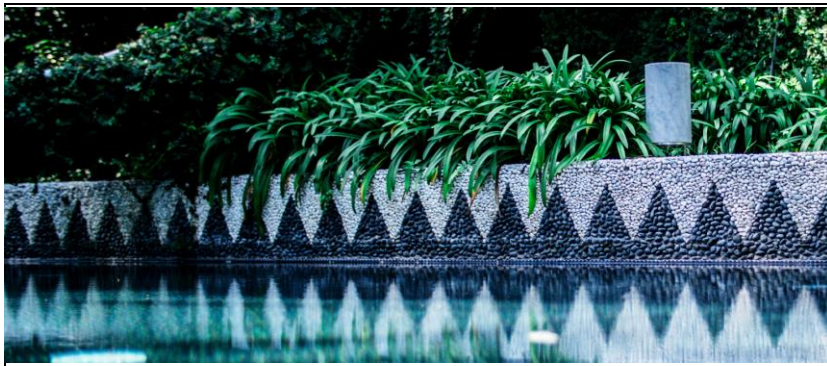

TALL CYLINDER



REF CODE				VP CHF
TLCY-TC		Tall CYLINDER_Terracotta Impruneta Aluminium painted graphite base	S 	1'550
TLCY-FG		Tall CYLINDER_Beachwood Aluminium painted graphite base	C	1'750
TLCY-TRW		Tall CYLINDER_Terracotta Raw Aluminium painted graphite base See variations on raw palette (pag 25)	S 	1'750
TLCY-CNP		Tall CYLINDER_Concrete Plus Aluminium painted graphite base See variations on concrete palette (pag 25)	S 	1'950
TLCY-TK		Tall CYLINDER_Teak Aluminium painted graphite base	C 	2'650
TLCY-ST		Tall CYLINDER_Basic Stones Aluminium painted graphite base See variations on basic stones palette (pag 24)	C 	2'950
TLCY-PM		Tall CYLINDER_Premium Stones Aluminium painted graphite base See variations on premium stones palette (pag 25)	C 	TBA

ALL ABOVE MENTIONED MODELS ARE PRICED CONSIDERING THE FOLLOWING FEATURES

Universal vertical output is suitable for both indoor & outdoor when cable arrives horizontally or underground. Gland option is strictly recommended in outdoor underground installations. See "Customization"

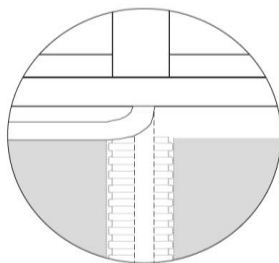

Universal cable output with rubber-feet (suitable for both indoor and outdoor)

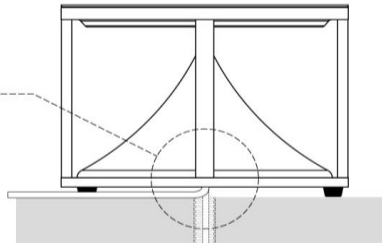





CUSTOMIZATION & ACCESSORIES

Please note that price for all optionals and accessories has to be added to the main model price

SUBWOOFER VERSION

Ref Code			
SUB-VER		Subwoofer Version	

BASE OPTIONALS

Ref Code			VP CHF
CYBS-SLV		Aluminium painted silver base	125
CYBS-RAL		Aluminium painted other RAL base	TBA
CYBS-INX		Stainless Steel 316L base (polish, satin or gunmetal finishing)	1'550
CYBS-BRS		Brass Base	TBA
CYBS-HIFI		Hi-Fi Push Button - Only for Aluminium version (see below)	75
VH-VER		Gland option (see below)	75

ACCESSORIES

Ref Code			VP CHF
PLAST220		Plaster treatment for travertines	275
AF-VER		Anti-theft for grass land*	125
SP-VER		Sand proof system	275
COVER		PVC cover	380

* Hard floor Anti-theft system is also available (info on request)





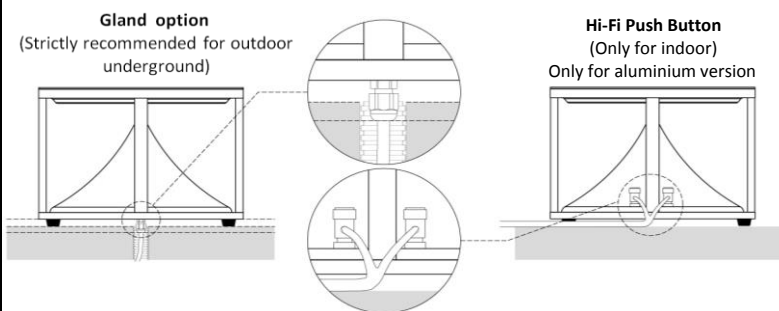

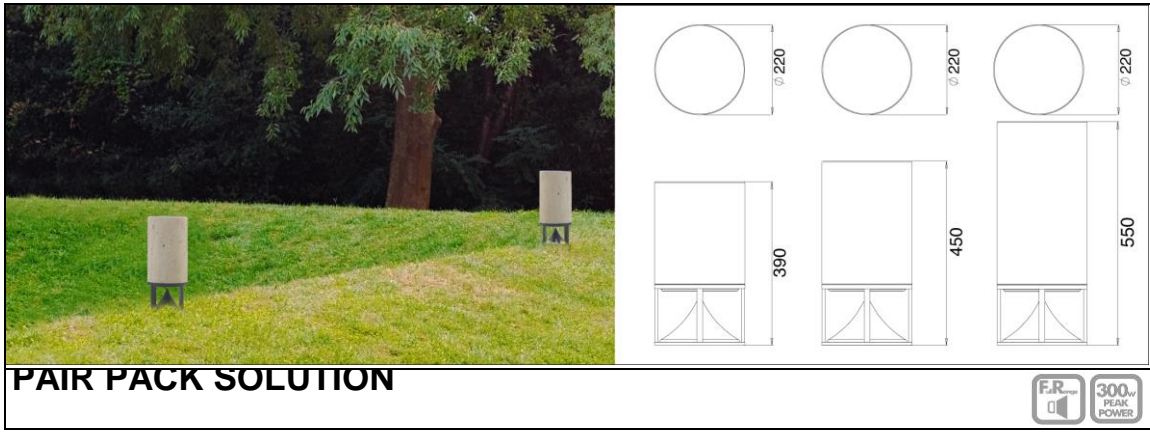

OUTPUT CABLE OPTIONS

Gland option (available for all bases) is strictly recommended for outdoor installations when cables run underground and the gland (higher than the rubber-feet) can be insert into the cable hole.





Hi-Fi Push Button (available only for indoor installations) is suitable for a simple and easier way to connect the module.



REF CODE		S	Pair
SHCY-PPTC	 <p>2 Short CYLINDER_Terracotta Impruneta Aluminium painted graphite base</p>		2'700
MDCY-PPCN	 <p>2 Medium CYLINDER_Concrete Aluminium painted graphite base See variations on concrete palette (pag 25)</p>		2'800
TLCY-PPCNP	 <p>2 Tall CYLINDER_Concrete Plus Aluminium painted graphite base See variations on concrete palette (pag 25)</p>		3'500
MDCY-PPSS	 <p>2 Medium CYLINDER_Solid Surface Betacryl only white Aluminium painted graphite base</p>		3'900

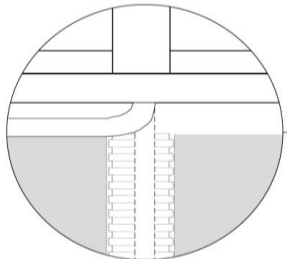
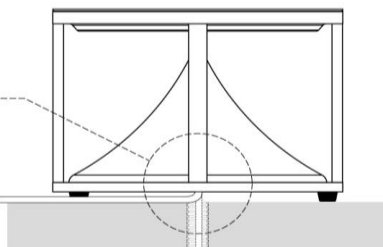

*prices refer to nr. 2 units in a single carton box

ALL ABOVE MENTIONED MODELS ARE PRICED CONSIDERING THE FOLLOWING FEATURES

<p>Universal vertical output is suitable for both indoor & outdoor when cable arrives horizontally or underground. Gland option is strictly recommended in outdoor underground installations. See "Customization"</p>		<p>Universal cable output with rubber-feet (suitable for both indoor and outdoor)</p> 	 <p>Aluminum painted graphite</p>
---	---	--	--

CUSTOMIZATION & ACCESSORIES

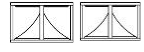
Please note that price for all optionals and accessories has to be added to the main model price

BASE OPTIONALS			
Ref Code			Pair
CYBS-SLV		2 Aluminium painted silver base	260
CYBS-RAL		2 Aluminium painted other RAL base	TBA
CYBS-INX		2 Stainless Steel 316L base (polish, satin or gunmetal finishing)	3'100
CYBS-BRS		2 Brass Base	TBA
CYBS-HIFI		2 Hi-Fi Push Button - Only for Aluminium version (see below)	160
VH-VER		2 Gland option (see below)	160

ACCESSORIES			
Ref Code			Pair
PLAST220		2 Plaster treatment for travertines	550
AF-VER		2 Anti-theft for grass land**	260
SP-VER		2 Sand proof system	550
COVER		2 PVC cover	760

**Hard floor Anti-theft system is also available (info on request)

*prices refer to nr. 2 units

OUTPUT CABLE OPTIONS

Gland option (available for all bases) is strictly recommended for outdoor installations when cables run underground and the gland (higher than the rubber-feet) can be insert into the cable hole.

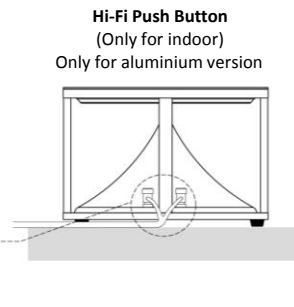
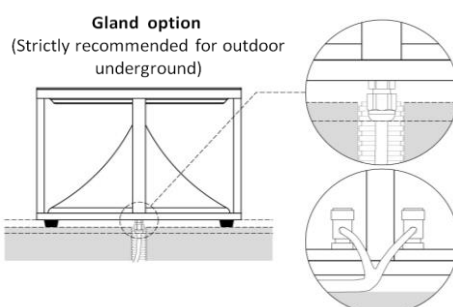



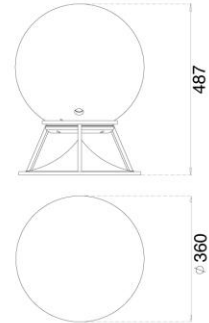
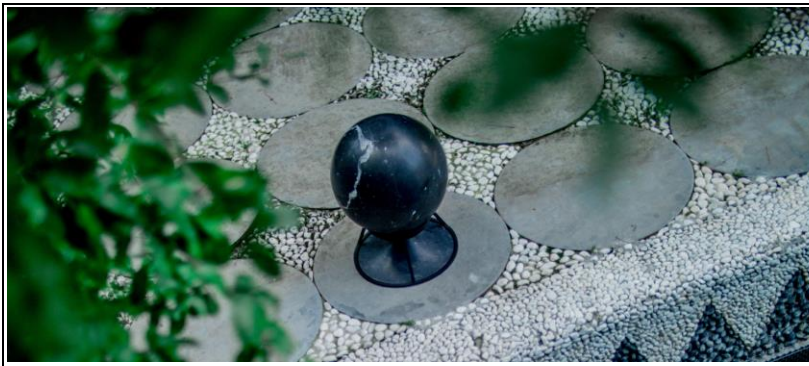









Hi-Fi Push Button (available only for indoor installations) is suitable for a simple and easier way to connect the module.



SPHERE_360





REF CODE				VP CHF
SF360-CN		Sphere 360_Concrete Steel painted graphite base See variations on concrete palette (pag 25)	S 	2'150
SF360-TC		Sphere 360_Terracotta Impruneta Steel painted graphite base	S 	2'350
SF360-TRW		Sphere 360_Terracotta Raw Steel painted graphite base See variations on raw palette (pag 25)	C 	2'550
SF360-CNP		Sphere 360_Concrete Plus Steel painted graphite base See variations on concrete palette (pag 25)	S 	2'750
SF360-ST		Sphere 360_Basic Stones Steel painted graphite base See variations on basic stones palette (pag 24)	C 	4'250
SF360-PM		Sphere 360_Premium Stones Steel painted graphite base See variations on premium stones palette (pag 25)	C 	TBA

ALL ABOVE MENTIONED MODELS ARE PRICED CONSIDERING THE FOLLOWING FEATURES

Horizontal cable output is suitable when cable arrives laterally for both indoor and outdoor installations.

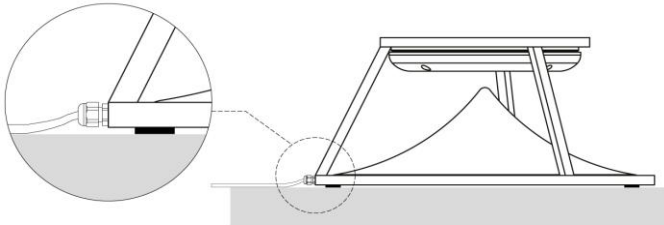
Simple (3 legs) base
Horizontal cable output with rubber-feet and gland





Steel painted graphite





CUSTOMIZATION & ACCESSORIES

Please note that price for all optionals and accessories has to be added to the main model price

SUBWOOFER VERSION

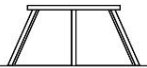
Ref Code		VP CHF
SUB-VER	 Subwoofer Version	

BASE OPTIONALS

Ref Code		VP CHF
SFBS-SLV	 Simple steel silver base	190
SFBS-RAL	 Simple steel other RAL base	TBA
SFBS-POL	 Simple stainless steel 316L base	460
SFBS-CLAS	 Classic stainless steel graphite/silver base*	460
SFBS-BRS	 Classic brass base*	TBA

* the gland is not available for classic bases

ACCESSORIES

Ref Code		VP CHF
PLAST360	Plaster tratment for travertines for 360	320
PLAST470	Plaster tratment for travertines for 470	675
VHGRS-VER	Anti theft for grass land	390
VHFLR-VER	Anti theft for hard floor	195
SP-VER	Sand proof system	360
COVER	PVC cover	380

OUTPUT CABLE OPTIONS

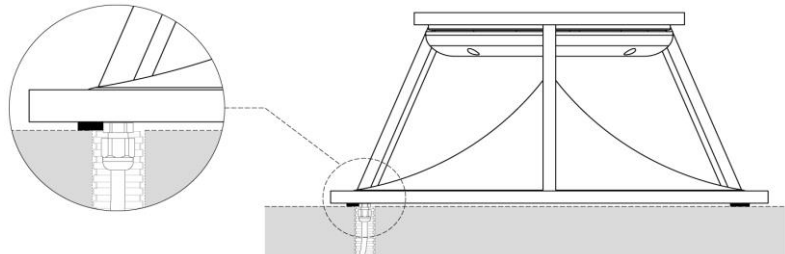
<p>Vertical output underground is particularly recommended for outdoor installations where cables run underground in order not to create problems during garden manteinance.</p>	<p>Vertical Cable Output underground with rubber-feet and gland</p> 
--	---

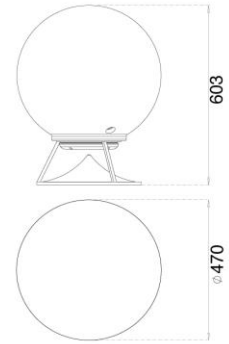



SPHERE_470

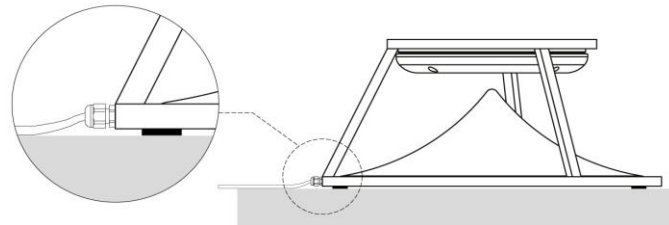

REF CODE				VP CHF
SF470-TC		Sphere 470_Terracotta Impruneta Steel painted graphite base	S 	3'350
SF470-TRW		Sphere 470_Terracotta Raw Steel painted graphite base See variations on raw palette (pag 25)	C 	3'550
SF470-ST		Sphere 470_Basic Stones Steel painted graphite base See variations on basic stones palette (pag 24)	C 	TBA
SF470-PM		Sphere 470_Premium Stones Steel painted graphite base See variations on premium stones palette (pag 25)	C 	TBA

ALL ABOVE MENTIONED MODELS ARE PRICED CONSIDERING THE FOLLOWING FEATURES

<p>Horizontal cable output is suitable when cable arrives laterally for both indoor and outdoor installations.</p>	<p>Simple (3 legs) base Horizontal cable output with rubber-feet and gland</p>		 <p>Steel painted graphite</p>





CUSTOMIZATION & ACCESSORIES

Please note that price for all optionals and accessories has to be added to the main model price

SUBWOOFER VERSION

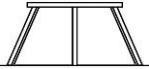
Ref Code			
SUB-VER		Subwoofer Version	

BASE OPTIONALS

Ref Code			VP CHF
SFBS-SLV		Simple steel silver base	195
SFBS-RAL		Simple steel other RAL base	TBA
SFBS-POL		Simple stainless steel 316L base	460
SFBS-CLAS		Classic stainless steel graphite/silver base*	460
SFBS-BRS		Classic brass base*	TBA

* the gland is not available for classic bases

ACCESSORIES

Ref Code			VP CHF
PLAST360		Plaster tratment for travertines for 360	320
PLAST470		Plaster tratment for travertines for 470	675
VHGRS-VER		Anti theft for grass land	390
VHFLR-VER		Anti theft for hard floor	195
SP-VER		Sand proof system	360
COVER		PVC cover	380

OUTPUT CABLE OPTIONS

Vertical output underground is particularly recommended for outdoor installations where cables run underground in order not to create problems during garden manteinance.

Vertical Cable Output underground with rubber-feet and gland

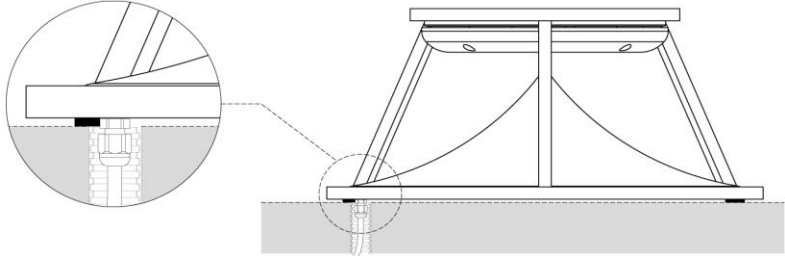



CUBE_400



REF CODE				VP CHF
CB400-CN		Cube 400_Concrete Steel painted graphite base Deflector in concrete See variations on concrete palette (pag 25)	S 	3'250
CB400-WOK		Cube 400_Oak Steel painted graphite base	C	4'850
CB400-WTK		Cube 400_Teak Steel painted graphite base	C 	5'450
CB400-ST		Cube 400_Basic Stones Steel painted graphite base See variations on basic stones palette (pag 24)	C 	5'650
CB400-PM		Cube 400_Premium Stones Steel painted graphite base See variations on premium stones palette (pag 25)	C 	TBA

ALL ABOVE MENTIONED MODELS ARE PRICED CONSIDERING THE FOLLOWING FEATURES

Universal vertical output is suitable for both indoor & outdoor when cable arrives horizontally or underground. Gland option is strictly recommended in outdoor underground installations. See "Customization"

Universal vertical cable output with rubber-feet (suitable for both indoor and outdoor)

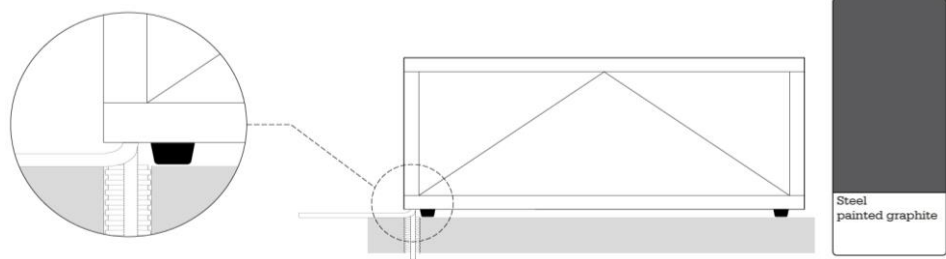



CUSTOMIZATION & ACCESSORIES

Please note that price for all optionals and accessories has to be added to the main model price

SUBWOOFER VERSION

Ref Code			
SUB-VER		Subwoofer Version	

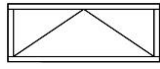
BASE OPTIONALS

Ref Code			VP CHF
CBBS-SLV		Steel painted silver base	360
CBBS-RAL		Steel painted others RAL base	TBA
CBBS-INX		Stainless Steel 316L base	3'100
CBBS-BRS		Brass base	TBA
VH-VER		Gland option (see below)	75

ACCESSORIES

Ref Code			VP CHF
PLAST400		Plaster treatment for travertines	450
SP-VER		Sand proof system	275
COVER		PVC Cover	470

OUTPUT CABLE OPTIONS

Gland option (available for all bases) is strictly recommended for outdoor installations when cables run underground and the gland (higher than the rubber-feet) can be insert into the cable hole.

Gland option
(Strictly recommended for outdoor underground)

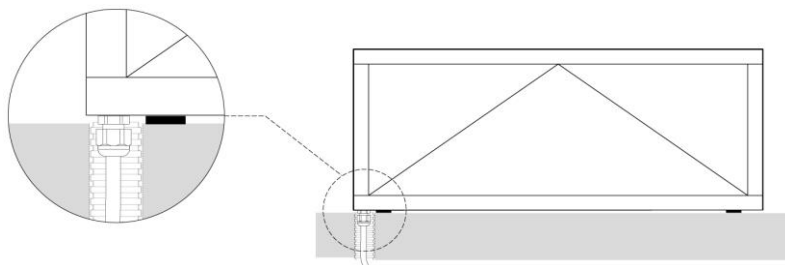





BLOCK_360



REF CODE		Block_Oak All oak wood			VP CHF
BCK360-WOK				3'650	4'550

REF CODE		Block_Teak All teak wood	 		VP CHF
BCK360-WTK				4'760	5'950

N.B. All above mentioned models are priced considering the following features.

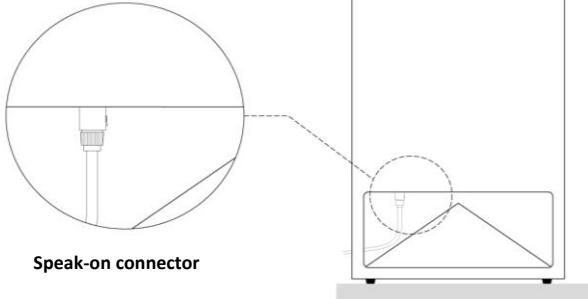

Speak-on connector

CUSTOMIZATION & ACCESSORIES

Please note that price for all optionals and accessories has to be added to the main model price

SUBWOOFER VERSION					
Ref Code					
SUB-VER		Subwoofer Version			

ACCESSORIES					
Ref Code					VP CHF
COVER		PVC Cover			460

OUTPUT CABLE OPTIONS

Hi-Fi Binding Posts-Gold Plated (only for indoor installations) is a different way to connect the module (no additional cost)

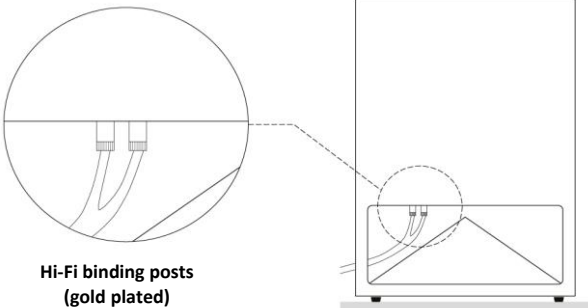

Hi-Fi binding posts (gold plated)



PERGOLA



REF CODE			VP CHF
PERGO-LA		Pergola_Line Array_Carbon Fiber Satellite module Outdoor applications DSP required	130w PEAK POWER C DSP REQUIRED 5'750
PERGO-PS		Pergola_Point Source_Carbon Fiber Satellite module Outdoor applications Supplied with external crossover (boxed)	120w PEAK POWER C X OVER 5'750

CUSTOMIZATION & ACCESSORIES

Please note that price for all optionals and accessories has to be added to the main model price

Ref Code		VP CHF
BODY-PNT	Painting other RAL (only body with grill black)	675
HSTD	Standard ceiling anchoring (2 pcs)	TBA
HSCA	Standard beam anchoring (2 pcs)	TBA
PG-HSM	Ceiling vertical iron	220
PG-HPM	Ceiling vertical steel	485
HDG-SELF	Floorstanding steel base	865
SP-VER	Sand proof filter	295
COVER	PVC Cover	550

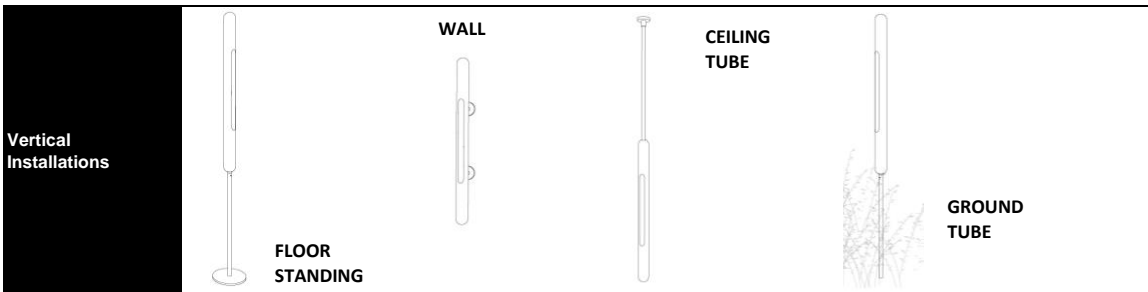
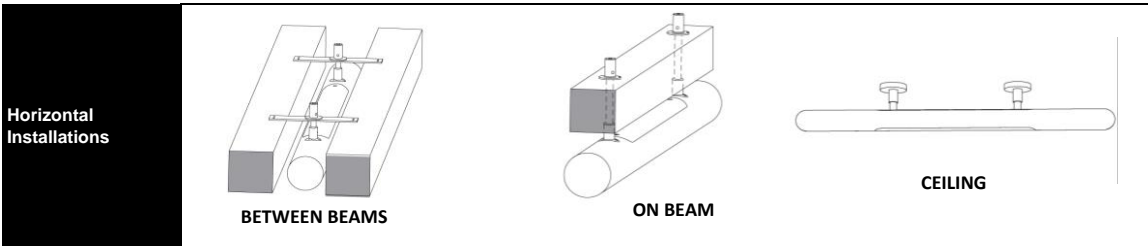

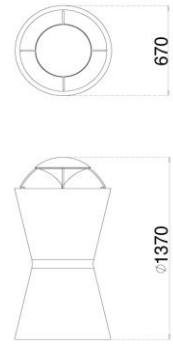

BIG YOYO



REF CODE
YOYO-BIG



Big Yoyo_Terracotta Impruneta
3 ways active module
Supplied with external 3ch amplifier with DSP



VP CHF

TBA

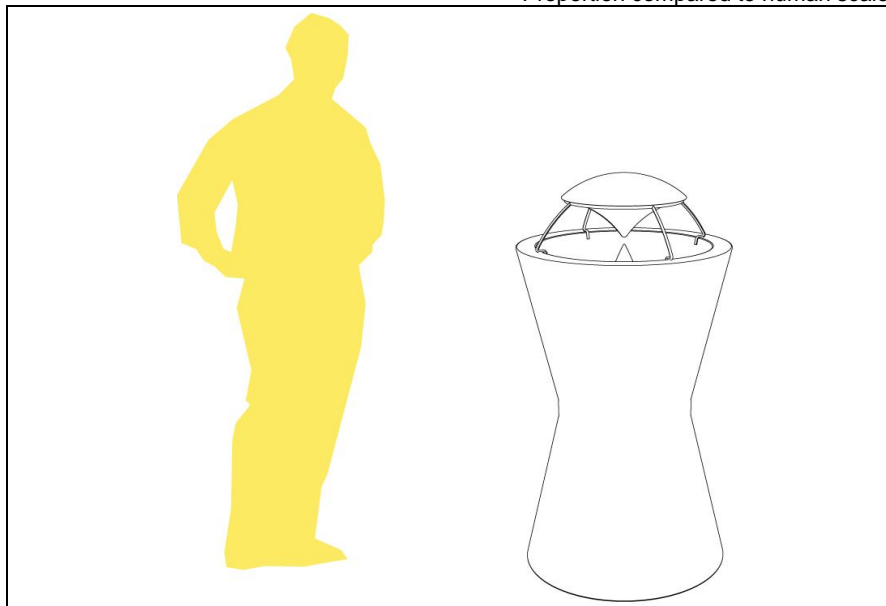

Proportion compared to human scale

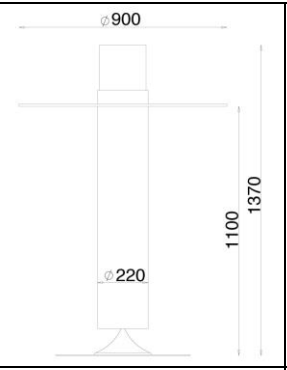



APOLLO



REF CODE	 <p>APOLLO Sonic outdoor fireplace table Metal painted body (black or white) Smoked glass Fueled by bioethanol</p>	 	VP CHF
			5'450





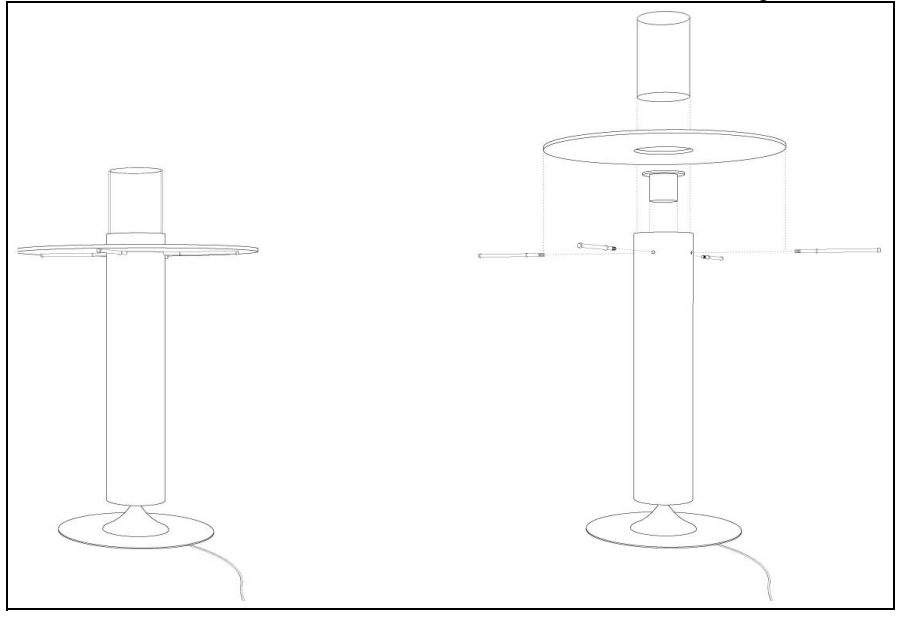

TAB-APO

Mounting instructions









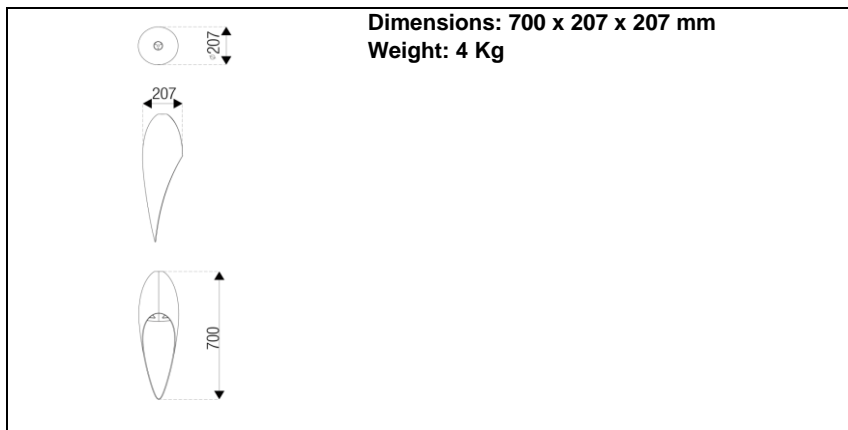





SUSPENDED MODULES

REF CODE		Small Drop Composite material (black or withe) Supplied with external crossover (boxed)	    	VP CHF
SMDRP				4'850

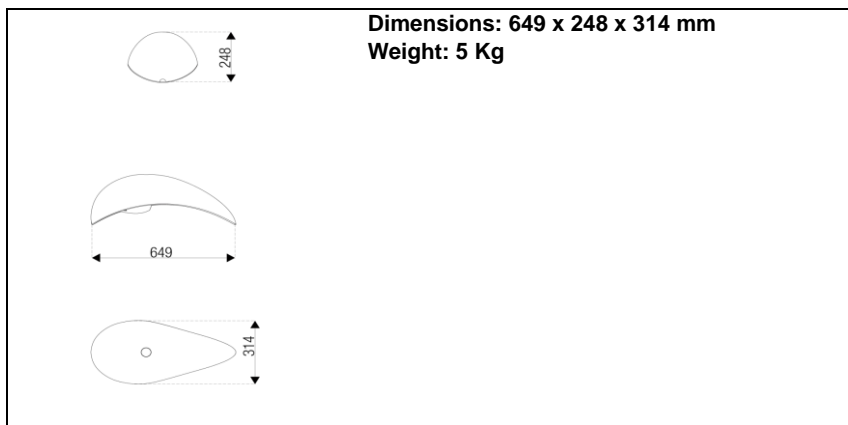



REF CODE		Small Helmet Composite material (black or withe) Supplied with external crossover (boxed)	    	VP CHF
SMHLM				4'500

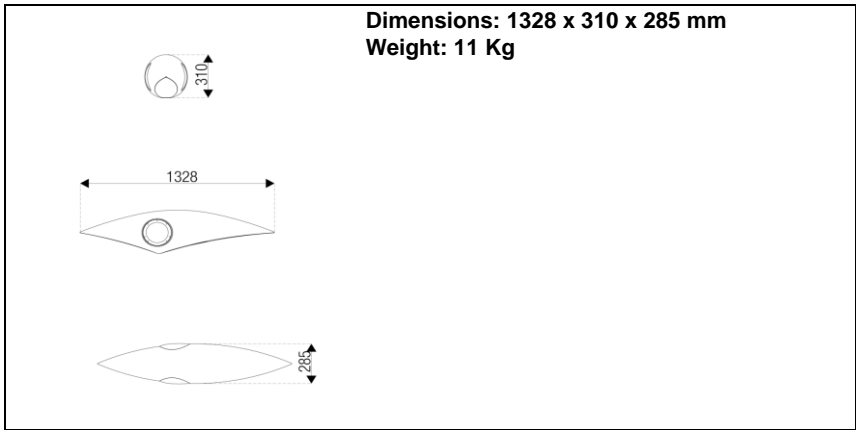

REF CODE	 <p>Shark_Sub Composite material (black or white) No crossover on board (passive)</p>	600W PEAK POWER	C	VP CHF
SHRK		SUB	 	5'450



REF CODE	 <p>Drop Composite material (black or white)</p>	300W PEAK POWER	C	VP CHF
DROP		F.R.	 	6'600

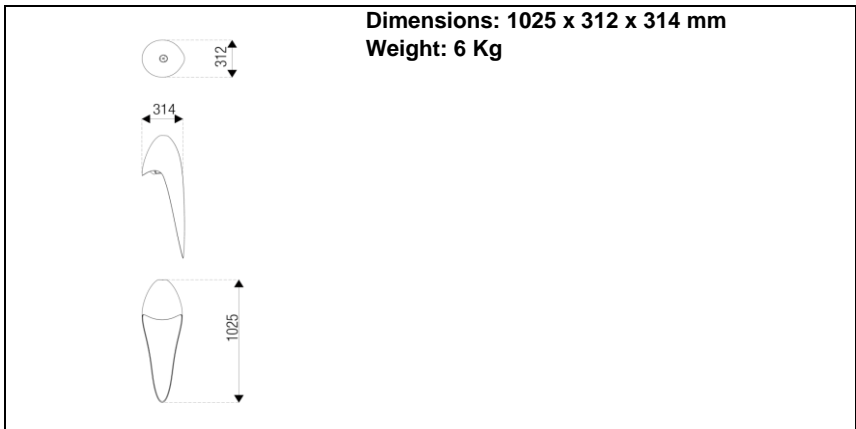

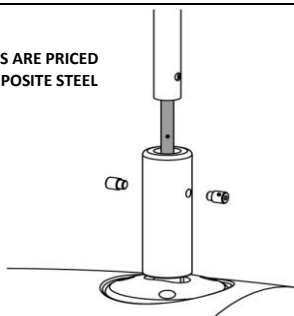
Steel tube mechanic	<p>ALL ABOVE MENTIONED MODELS ARE PRICED CONSIDERING THEM IN THE COMPOSITE STEEL TUBE MECHANIC</p> 	<p>In case the Steel tube is needed for an installation please provide the following information:</p> <ul style="list-style-type: none"> -Length of the tube - Proper anchoring system facing the ceiling or the wall.
--------------------------------	--	--

CUSTOMIZATION & ACCESSORIES

Please note that price for all optionals and accessories has to be added to the main model price

Ref Code		VP CHF
SUSP-RAL	Painting others RAL	TBA
HSTD	Standard hanging typologies	75
HSM	Iron hanging not oriented	220
HPM	Steel hanging not oriented	485
HBEAM	Beam hanging	395
H45D	Orientable 45 steel hanging	495
H90D	Orientable 90 steel hanging	650
HWSP	Widening plate for orientable hanging	75
SP-VER	Sand proof filter*	195
COVER	PVC cover small (for small drop/helmet)	590
COVER	PVC cover large (for shark/drop)	760

*Not available for Shark

HANGING MECHANIC OPTION

Steel cable
mechanic

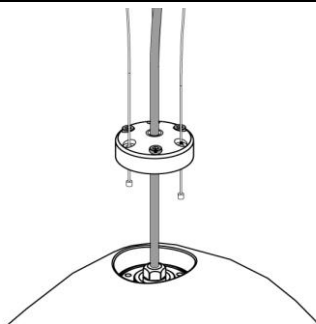



Steel cable
suspension
option is
recommended in
outdoor
installations when
the loudspeaker
has to be
anchored to the
brances of a tree
or to other
supporting
structures.



AMPLIFIERS_ Master Volume

Ice Power Technology - Table stand with rack mounting kit included

REF CODE			VP CHF
ASC6EVO		AS-C6 EVO 6 ch x 450W @4Ω Property Audio processor	4'200
ASH4EVO		AS-H4 EVO 2 ch x 1100W + 2ch x 500W @4Ω Hybrid Multichannel Property Audio processor	6'550
ASC4		AS-C4 4 ch x 450W @4Ω	3'750
ASCUST		AS Customized Unit	TBA

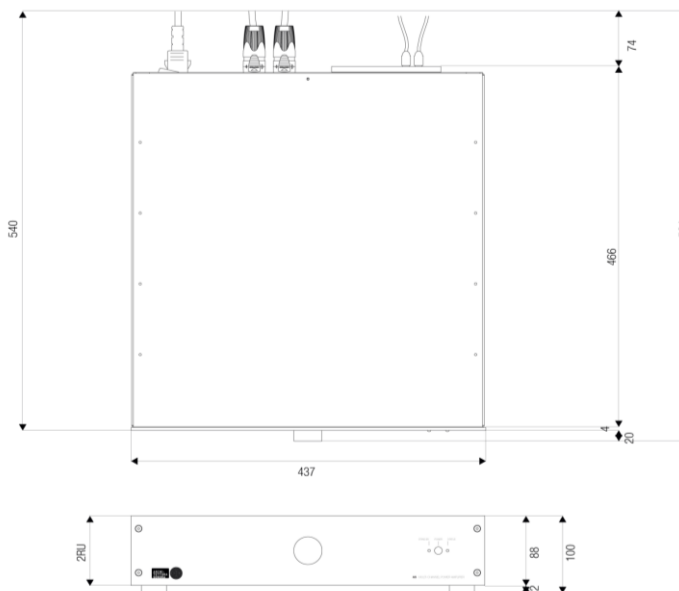

Dimensions:
 For rack mounting: 2RU, 540
 depth
 (cables and connectors
 included)

For furniture mounting:
 100mm high x 440 wide x
 564mm depth
 (rotary knob, cables and
 connectors included)

Weight:
 from 9.2 Kg to 12 kg
 (depending on the model)

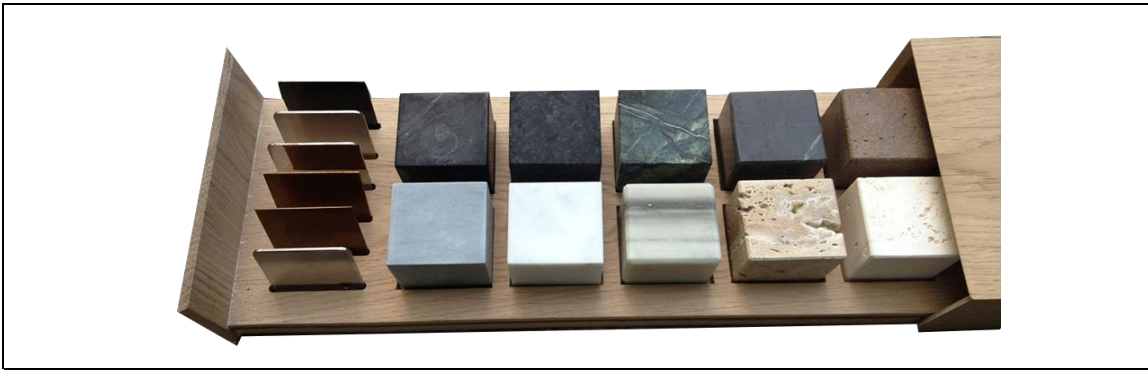

A.S. KITS

REF CODE			VP CHF
<p><i>ASKIT</i></p>	 <p style="text-align: center;">A.S. Sample Kit</p> <p>This elegant A.S. wooden Sample Kit box is the the best tool to hold a range of our exclusive stones and metals in your hand and get a feel of the various qualities and surface finishes.</p>		<p>860</p>
<p><i>ASMNT</i></p>	 <p style="text-align: center;">A.S. Professional Maintenance kit</p> <p>AS provides customers with a professional Maintenance Kit to keep your speakers beautiful as long as possible. The kit includes professional products to treat stone, metal wood and composite materials.</p> <p>We warmly recommend doing maintenance at least a year.</p>		<p>630</p>