

**ARCHI-
TETTURA
SONORA**

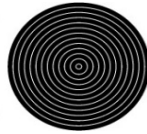

Architettura Sonora SWISS Pricelist 2022









SOUND MATTERS



B&W Group (Schweiz) GmbH
Ifangstrasse 5, 8952 Schlieren
www.bwgroup.ch
043 433 61 50

Preise in Schweizer Franken, inklusive MWST
Prix en Francs Suisse, inclus TVA

2022 v1.2.
Effective from July, 1st 2022



TABLE OF CONTENTS

ICARUS								from page 1
								
ICARUS Stand Alone	Icarus Sub	Icarus Wall	Icarus MultiWall	Icarus MultiCeiling	Icarus MultiStand	Icarus MultiGround		



CYLINDER					from page 15
					
MEDIUM CYLINDER	TALL CYLINDER	CYLINDER TABLE			



SPHERE				from page 20
				
SPHERE_360	SPHERE_470			



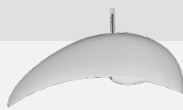

SPHERINA					from page 24
					
SPHERINA_Air	SPHERINA_Midair	SPHERINA_Floor			

CUBE							from page 30
							
CUBINO	CUBE_400	CUBE_400 TEN	CUBE_2LV SUB				

PERGOLA			page 36
			
POINT SOURCE	LINE ARRAY		
	Horizontal	Vertical	

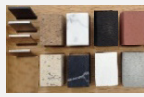





AERIAL				from page 37
				
Small DROP	Small HELMET	DROP	SHARK (Sub)	

AMPLIFIERS		page 40
		
AS Amplifiers	POWERSOFT Amplifiers	

PROMO KITS					from page 41
					
BASIC Sample Kit	PREMIUM Sample Kit	T-SHIRT	BAG	CATALOGUES	



ICARUS_Stand Alone

REF CODE		CHF	UVP
ICA-CN ICA-CNP ICA-CNW ICA-CNR ICA-CNB	 <p>ICARUS_Concrete Bodies in Concrete Metal parts in polished Steel 304 > see table on the next page See variations on concrete palette at the end</p> <p> CN GREY CNP BLACK CNW WHITE CNR RED CNB OceanBlue </p>		4'950
ICA-ST01 ICA-ST02 ICA-ST03 ICA-ST04	 <p>ICARUS_Basic Stones Bodies in Basic Stones Metal parts in polished Steel 304 > see table on the next page See variations on Concrete palette at the end</p> <p> ST01 TRVC ST02 TRVW ST03 CARW ST04 MARQ </p>		9'900
ICA-PM	 <p>ICARUS_Premium Bodies in Premium Stones Metal parts in polished Steel 304 > see table on the next page See variations on Premium Stones palette at the end</p>		POR



MAIN FUNCTIONAL OPTIONS

Please note that price for all the following options has to be added to the main model price

REF CODE		CHF	UVP
ICA-HZ60	 <p>HIGH IMPEDANCE ON BOARD 70/100V - 60W</p>		300

CUSTOMIZATION & ACCESSORIES

Please note that price for all the following options and accessories has to be added to the main model price

REF CODE		CHF	UVP
ICA-MTL-BLK	 <p>Metal parts in MATT BLACK painted Steel 304 > see table on the next page</p>		730
ICA-MTL-SAT	 <p>Metal parts in SATIN-finished Steel 304 > see table on the next page</p>		920
ICA-MTL-POL316	 <p>Metal parts in POLISHED Steel 316L > see table on the next page</p>		1'470

ICA-MTL-BRS		Metal parts in Brass > see table on the next page		920
PLAST-ICA		Plaster treatment for travertines		450
POL-ICA		Polishing treatment for all marbles		380
COVER-ICA-B		PVC Basic Envelope		190

METAL FINISHES TABLE

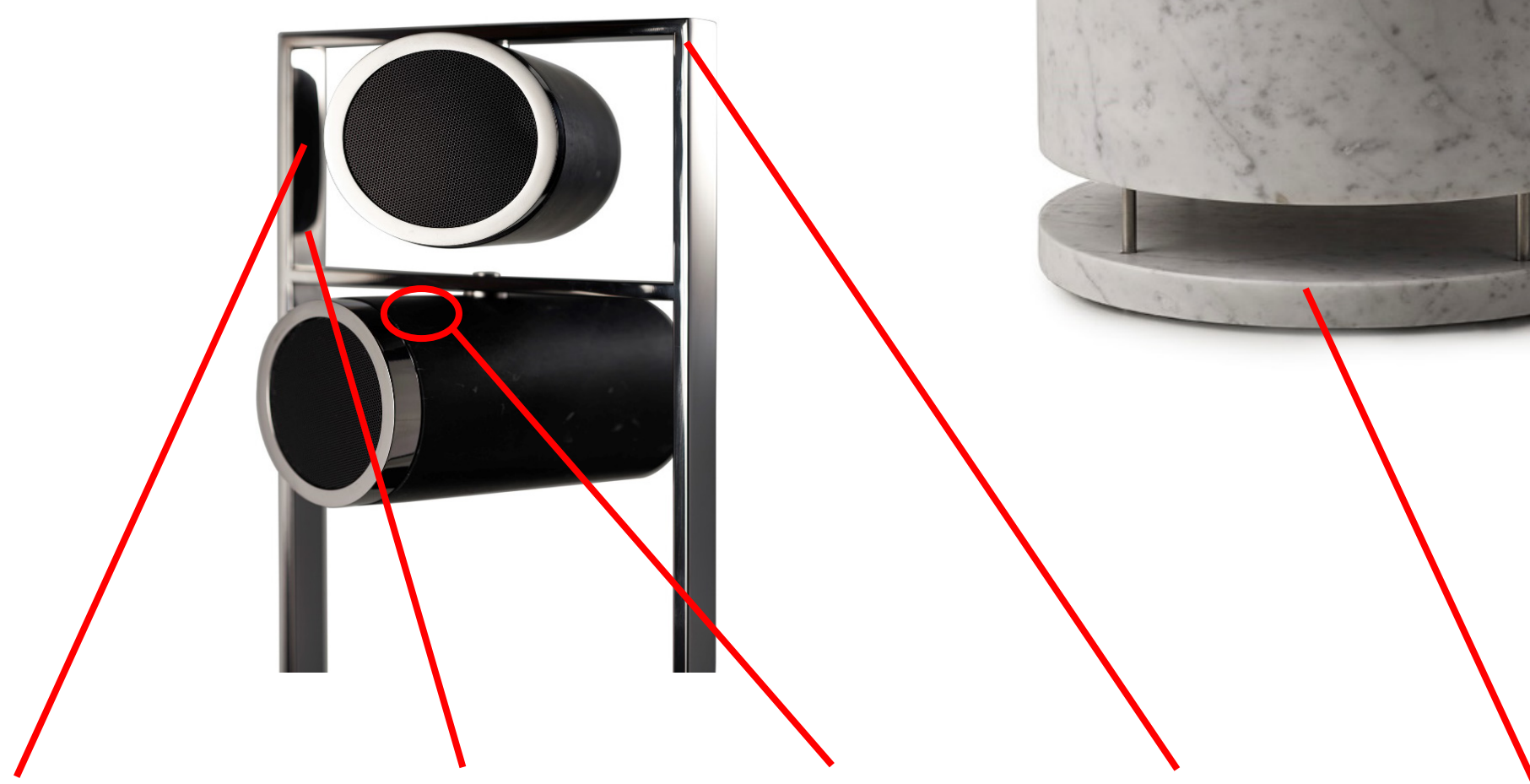

VERSION	GRID	COVER	JOINT	FRAME	LEGS
STEEL 304 POLISHED	BLACK	304 POLISHED	304 POL	304 POL	304 POL
STEEL 304 SATIN	BLACK	304 SATIN	304 SAT	304 SAT	304 SAT
STEEL 316L POLISHED	BLACK	316L POLISHED	316L POL	316L POL	316 POL
STEEL 304 BLACK PAINT	BLACK	304 BLACK	304 POL	304 BLACK	304 BLACK
BRASS	BLACK	BRASS	BRASS	BRASS	BRASS

Standard version highlighted in red

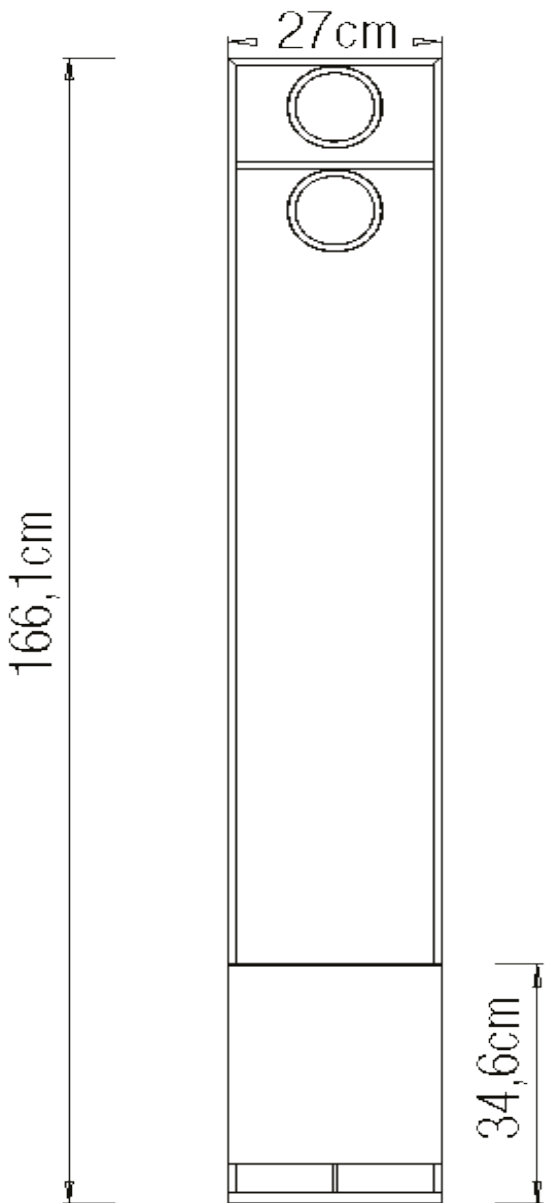

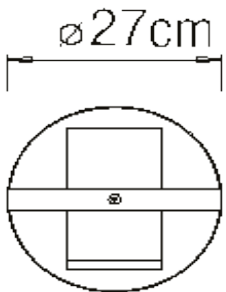

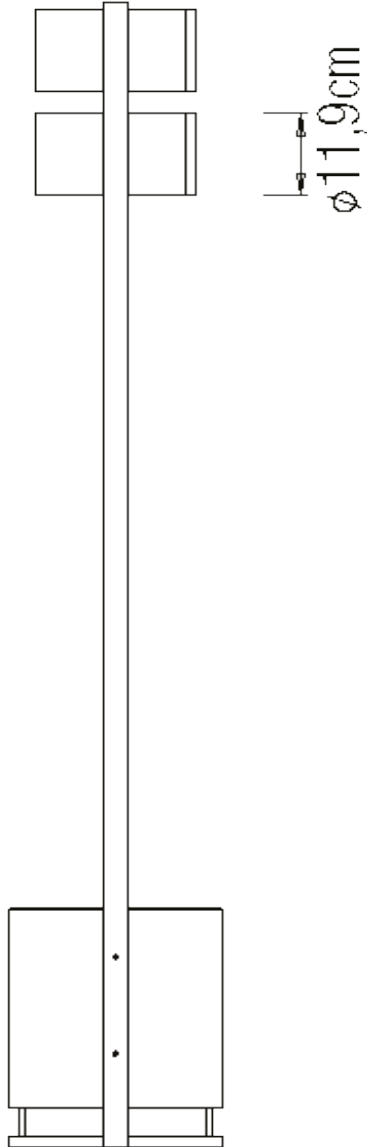



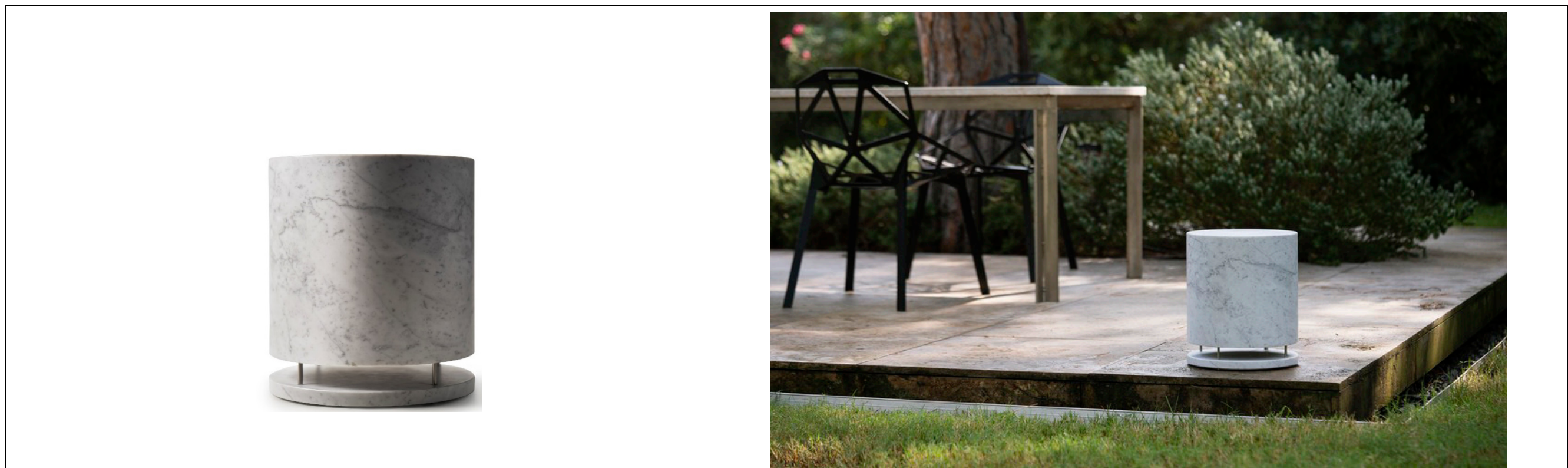



Net Weight	31 Kg Concrete 34 Kg Marble
Shipping Weight	38 Kg 42 Kg
Shipping Box	180x40x40 cm
H.T.S. CODE	85.18.22.00



ICARUS_SUB

REF CODE		CHF	UVP
ICASUB-CN ICASUB-CNP ICASUB-CNW ICASUB-CNR ICASUB-CNB	 <p>ICARUS SUB_Concrete Body in Concrete Aluminium matt black painted legs > see table on the next page See variations on Concrete palette at the end</p> <p> CN GREY CNP BLACK CNW WHITE CNR RED CNB OceanBlue </p>		1'780
ICASUB-ST01 ICASUB-ST02 ICASUB-ST03 ICASUB-ST04	 <p>ICARUS SUB_Basic Stones Body in Basic Stone Aluminium matt black painted legs > see table on the next page See variations on concrete palette at the end</p> <p> ST01 TRVC ST02 TRVW ST03 CARW ST04 MARQ </p>		4'190
ICASUB-PM	 <p>ICARUS SUB_Premium Body in Premium Stone Aluminium matt black painted legs > see table on the next page See variations on concrete palette at the end</p>		POR

MAIN FUNCTIONAL OPTIONS

Please note that price for all the following options has to be added to the main model price

ICASUB-HZ30		HIGH IMPEDANCE ON BOARD 70/100V - 30W	105
ICASUB-HZ60		HIGH IMPEDANCE ON BOARD 70/100V - 60W	140

CUSTOMIZATION & ACCESSORIES

Please note that price for all the following options and accessories has to be added to the main model price

REF CODE		CHF	UVP
ICASUB-LGS-SAT		SATIN-finished Steel 304 Legs > see table on the next page	185
ICASUB-LGS-POL		POLISHED Steel 304 Legs > see table on the next page	220
ICASUB-LGS-POL316		POLISHED Steel 316L Legs > see table on the next page	315
ICASUB-LGS-BRS		Oxidized BRASS Legs > see table on the next page	260
PLAST-ICASUB		Plaster treatment for travertines	260
POL-ICASUB		Polishing treatment for all marbles	190
COVER-ICASUB-B		PVC Basic Envelope	105

	Net Weight	22 Kg Concrete 24 Kg Marble
	Shipping Weight	24 Kg Concrete; 27 kg Marble
	Shipping Box	40x40x45 cm
	H.T.S. CODE	85.18.21.00

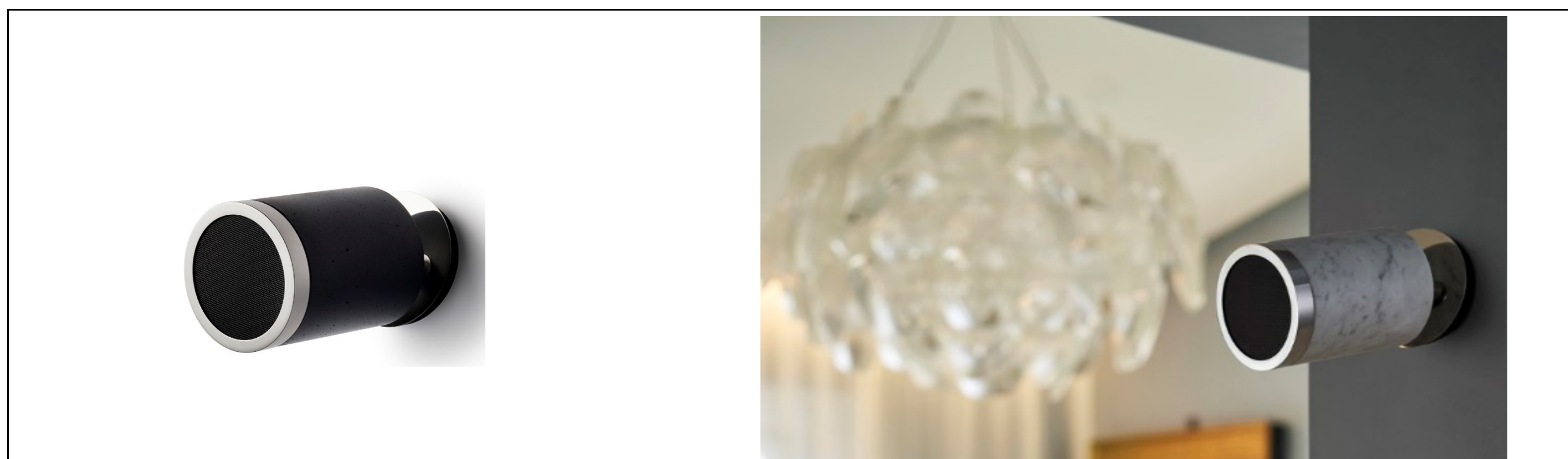









ICARUS_WALL

FIXED Joint Version

REF CODE		CHF	UVP Stk x2*
ICAWALL-FIX-PPCN ICAWALL-FIX-PPCNP ICAWALL-FIX-PPCNW ICAWALL-FIX-PPCNR ICAWALL-FIX-PPCNB	<p>ICARUS WALL_Fixed Joint_Concrete PAIR-PACK Body in Concrete Covers in polished Steel 304 > see table on the next page See variations on Concrete palette at the end</p> <p> CN GREY CNP BLACK CNW WHITE CNR RED CNB OceanBlue </p>	 	1'480
ICAWALL-FIX-PPST01 ICAWALL-FIX-PPST02 ICAWALL-FIX-PPST03 ICAWALL-FIX-PPST04	<p>ICARUS WALL_Fixed Joint_Basic Stones PAIR-PACK SOLUTION Body in Basic Stone Covers in polished Steel 304 > see table on the next page See variations on Basic Stones palette at the end</p> <p> ST01 TRVC ST02 TRVW ST03 CARW ST04 MARQ </p>	 	3'490
ICAWALL-FIX-PPPM	<p>ICARUS WALL_Fixed Joint_Premium PAIR-PACK SOLUTION Body in Premium Stone Covers in polished Steel 304 > see table on the next page See variations on Premium Stones palette at the end</p>	 	POR

*prices refer to nr.2 units in a single carton box

SPHERICAL Joint Version			
REF CODE		CHF	UVP Stk x2*
ICAWALL-SPH-PPCN	 <p>ICARUS WALL_Spherical Joint_Concrete PAIR-PACK SOLUTION Body in Concrete Covers in polished Steel 304 > <i>see table on the next page</i> See variations on Concrete palette at the end</p> <p>CN GREY CNP BLACK CNW WHITE CNR RED CNB OceanBlue</p>	 	1'650
ICAWALL-SPH-PPCNP			
ICAWALL-SPH-PPCNW			
ICAWALL-SPH-PPCNR			
ICAWALL-SPH-PPCNB			
ICAWALL-SPH-PPST01	 <p>ICARUS WALL_Spherical Joint_Basic Stones PAIR-PACK SOLUTION Body in Basic Stone Covers in polished Steel 304 > <i>see table on the next page</i> See variations on Basic Stones palette at the end</p> <p>ST01 TRVC ST02 TRVW ST03 CARW ST04 MARQ</p>	 	3'680
ICAWALL-SPH-PPST02			
ICAWALL-SPH-PPST03			
ICAWALL-SPH-PPST04			
ICAWALL-SPH-PPPM	 <p>ICARUS WALL_Fixed Joint_Premium PAIR-PACK SOLUTION Body in Premium Stone Covers in polished Steel 304 > <i>see table on the next page</i> See variations on Premium Stones palette at the end</p>	 	POR

*prices refer to nr.2 units in a single carton box

MAIN FUNCTIONAL OPTIONS



Please note that price for all the following options has to be added to the main model price

REF CODE		CHF	UVP Stk x2*
ICAWALL-PPHZ10	 <p>HIGH IMPEDANCE ON BOARD 70/100V - 10W</p>		75

*prices refer to nr.2 units in a single carton box

CUSTOMIZATION & ACCESSORIES

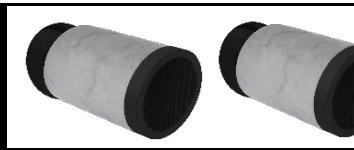
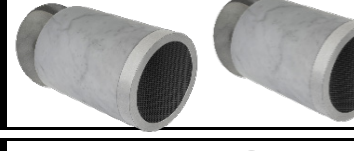
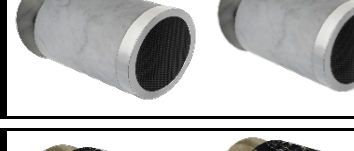
Please note that price for all the following options and accessories has to be added to the main model price

REF CODE		CHF	UVP Stk x2*
ICAWALL-MTL-PPBLK	 <p>Metal parts in MATT BLACK painted Steel 304 > <i>see table on the next page</i></p>		220
ICAWALL-MTL-PPSAT	 <p>Metal parts in SATIN-finished Steel 304 > <i>see table on the next page</i></p>		375
ICAWALL-MTL-PPPOL316	 <p>Metal parts in POLISHED Steel 316L > <i>see table on the next page</i></p>		1'190
ICAWALL-MTL-PPBRS	 <p>Metal parts in oxidized BRASS > <i>see table on the next page</i></p>		920
PLAST-ICAWALL	Plaster treatment for travertines		190
POL-ICAWALL	Polishing treatment for all marbles		135
COVER-ICAWALL-P	PVC Premium Cover		105

*prices refer to treatments and options applied on nr. 2 pieces

METAL FINISHES TABLE



VERSION	GRID	COVER	JOINT*	DISC	PLATE
STEEL 304 POL	BLACK	304 POLISHED	304 POL	304 POL	ALUMINIUM BLACK
STEEL 304 SATIN	BLACK	304 SATIN	304 SAT	304 SAT	ALUMINIUM BLACK
STEEL 316L POLISHED	BLACK	316L POLISHED	316L POL	316L POL	ALUMINIUM BLACK
STEEL 304 BLACK PAINT	BLACK	304 BLACK	304 POL	304 BLACK	ALUMINIUM BLACK
BRASS	BLACK	BRASS	BRASS	BRASS	ALUMINIUM BLACK

Standard version highlighted in red

**In the "Fixed Joint" version, the joint is always in POLISHED steel 304*

Net Weight	5 Kg (2 pcs)
Shipping Weight	6 Kg (2 pcs)
Shipping box	34x38x20 cm
H.T.S. Code	85.18.21.00



ICARUS_MULTIWALL



only indoors

REF CODE		CHF	UVP
ICAMLWL-CN ICAMLWL-CNP ICAMLWL-CNW ICAMLWL-CNR ICAMLWL-CNB	<p>ICARUS MULTI-WALL_Concrete Without Crossover - Bodies in Concrete Plate in black painted metal Covers and Spherical Joint in polished Steel 304 > see table on the next page</p> <p>Only for indoor use See variations on Concrete palette at the end</p>	 	1'350
ICAMLWL-ST01 ICAMLWL-ST02 ICAMLWL-ST03 ICAMLWL-ST04	<p>ICARUS MULTI-WALL_Basic Stones Without Crossover - Bodies in Basic Stones Plate in black painted metal Covers and Spherical Joint in polished Steel 304 > see table on the next page</p> <p>Only for indoor use See variations on Basic Stones palette at the end</p>	 	2'390
ICAMLWL-PM	<p>ICARUS MULTI-WALL_Premium Without Crossover - Bodies in Premium Stones Plate in black painted metal Covers and Spherical Joint in polished Steel 304 > see table on the next page</p> <p>Only for indoor use See variations on Premium Stones palette at the end</p>	 	POR

MAIN FUNCTIONAL OPTIONS

Please note that price for all the following options has to be added to the main model price

REF CODE		CHF	UVP
ICAMLWL-HZ20	<p>HIGH IMPEDANCE ON BOARD 70/100V - 20W</p>		75

CUSTOMIZATION & ACCESSORIES

Please note that price for all the following options and accessories has to be added to the main model price

REF CODE		CHF	UVP
ICAMLWL-MTL-BLK	<p>Metal parts in MATT BLACK painted Steel 304 > see table on the next page</p>		220
ICAMLWL-MTL-SAT	<p>Metal parts in SATIN-finished Steel 304 > see table on the next page</p>		460
ICAMLWL-MTL-POL	<p>Metal parts in POLISHED Steel 304 > see table on the next page</p>		315
ICAMLWL-MTL-POL316	<p>Metal parts in POLISHED Steel 316L > see table on the next page</p>		1'390

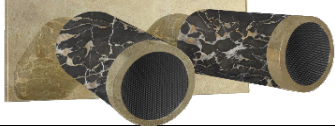
ICAMLWL-MTL-BRS	 Metal parts in oxidized BRASS > see table on the next page	650
PLAST-ICAMLWL	Plaster treatment for travertines	115
POL-ICAMLWL	Polishing treatment for all marbles	95

METAL FINISHES TABLE



Only Indoors

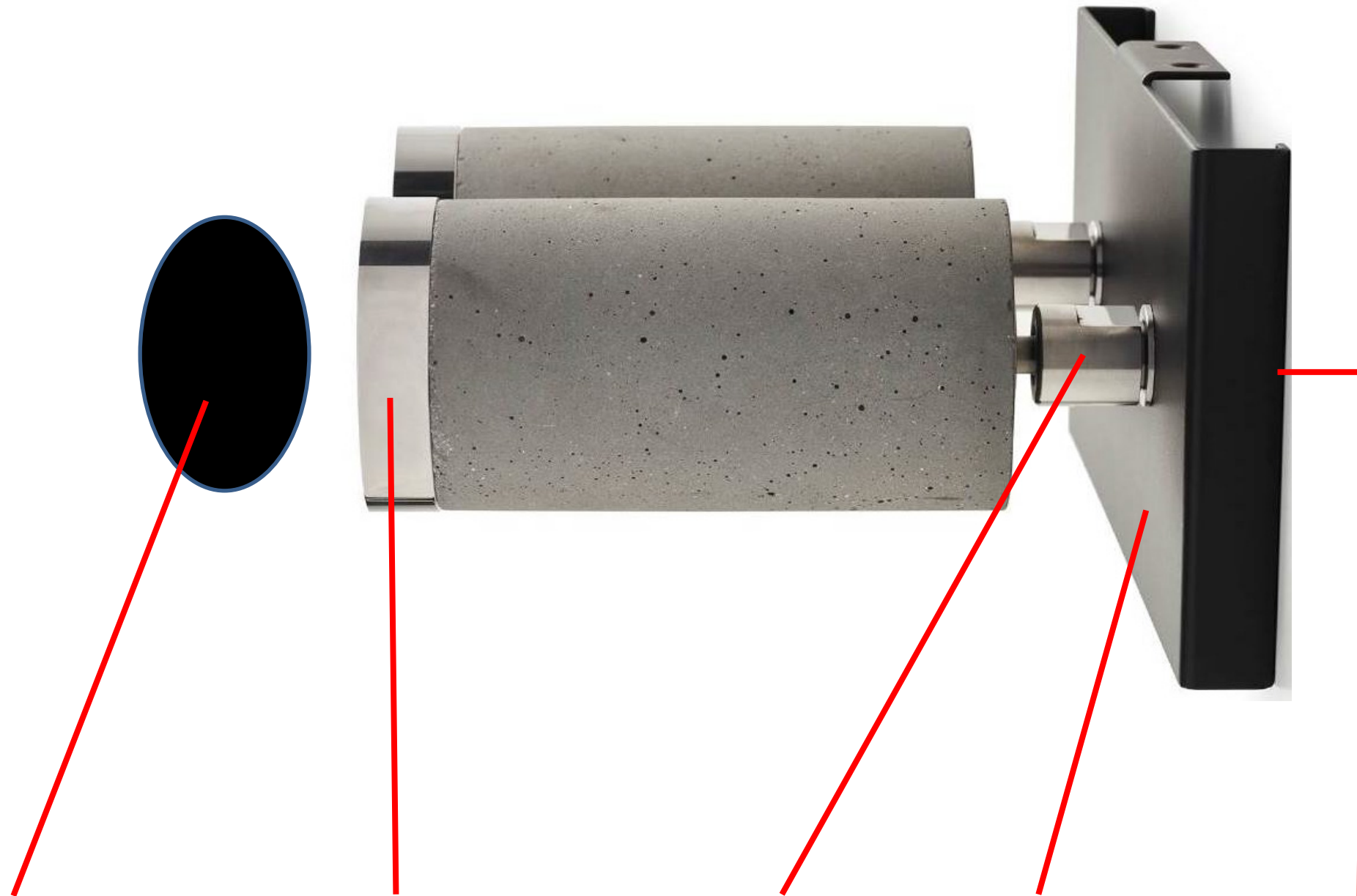







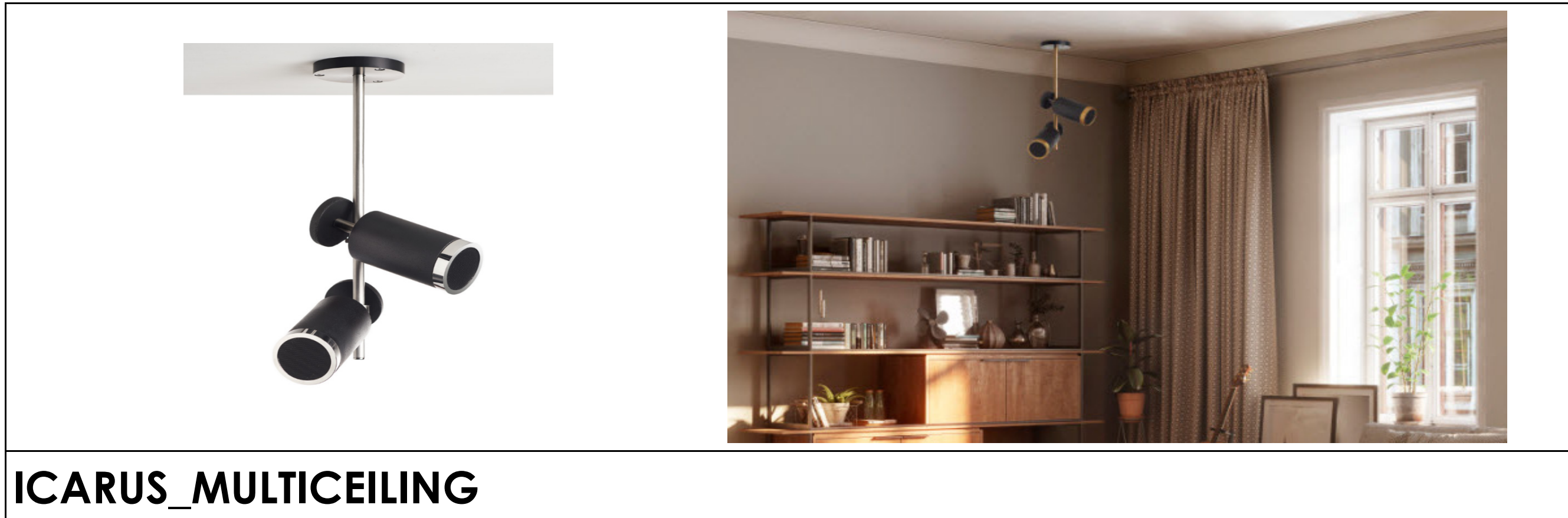









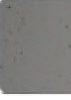



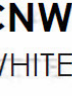





VERSION	GRID	COVER	JOINT	FRONT PLATE	WALL SUPPORT
STANDARD MIX	BLACK	304 POLISHED	304 POL	BLACK	BLACK
STEEL 304 POLISHED	BLACK	304 POLISHED	304 POL	304 POL	BLACK
STEEL 304 SATIN	BLACK	304 SATIN	316L SAT	304 SAT	BLACK
STEEL 304 BLACK PAINT	BLACK	304 BLACK	304 POL	BLACK	BLACK
BRASS	BLACK	BRASS	BRASS	BRASS	BLACK
STEEL 316L POLISHED	BLACK	316L POLISHED	316L POL	316L POL	BLACK

Standard version highlighted in red

Net Weight	3 Kg
Shipping Weight	4 Kg
Shipping box	30x23x35 cm
H.T.S. Code	85.18.22.00



ICARUS_MULTICEILING

REF CODE		CHF	UVP
ICAMLCE-CN  ICAMLCE-CNP  ICAMLCE-CNW  ICAMLCE-CNR  ICAMLCE-CNB 	 <p>ICARUS_MULTICEILING_Concrete Without Crossover - Bodies in Concrete Metal parts in polished Steel 304 > see table on the next page See variations on Concrete palette at the end</p> <p> CN  CNP  CNW  CNR  CNB  <small>GREY BLACK WHITE RED OceanBlue</small> </p>	 	950 1'400
ICAMLCE-ST01  ICAMLCE-ST02  ICAMLCE-ST03  ICAMLCE-ST04 	 <p>ICARUS_MULTICEILING_Basic Stones Without Crossover - Bodies in Basic Stone Metal parts in polished Steel 304 > see table on the next page See variations on Basic Stones palette at the end</p> <p> ST01  ST02  ST03  ST04  <small>TRVC TRVW CARW MARQ</small> </p>	 	2'200 3'200
ICAMLCE-PM	 <p>ICARUS_MULTICEILING_Premium Without Crossover - Bodies in Premium Stone Metal parts in polished Steel 304 > see table on the next page See variations on Premium Stones palette at the end</p>	 	POR POR



MAIN FUNCTIONAL OPTIONS

Please note that price for all the following options has to be added to the main model price

REF CODE		CHF	UVP
ICAMLCE-HZ20	 <p>HIGH IMPEDANCE ON BOARD 70/100V - 20W</p>	40	60

CUSTOMIZATION & ACCESSORIES

Please note that price for all the following options and accessories has to be added to the main model price

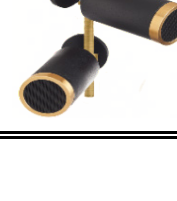
REF CODE		CHF	UVP
ICAMLCE-MTL-BLK	 <p>COVERS in MATT BLACK painted Steel 304 > see table on the next page</p>		200
ICAMLCE-MTL-SAT	 <p>Metal parts in SATIN-finished Steel 304 > see table on the next page</p>		550
ICAMLCE-MTL-POL316	 <p>Metal parts in POLISHED Steel 316L > see table on the next page</p>		920
ICAMLCE-MTL-BRS	 <p>Metal parts in oxidized BRASS > see table on the next page</p>		830
PLAST-ICAMLCE	Plaster treatment for travertines		115
POL-ICAMLCE	Polishing treatment for all marbles		95
COVER-ICAMLCE-B	PVC Basic Envelope		150

METAL FINISHES TABLE



VERSION	GRID	COVER	JOINT	PLATE	POLE*
STEEL 304 POLISHED	BLACK	304 POLISHED	304 POL	BLACK	304 POL
STEEL 304 SATIN	BLACK	304 SATIN	304 SAT	BLACK	304 POL
STEEL 316L POLISHED	BLACK	316L POLISHED	316 POL	BLACK	316L POL
STEEL 304 BLACK PAINT	BLACK	304 BLACK	304 POL	BLACK	304 POL
BRASS	BLACK	BRASS	BRASS	BLACK	BRASS





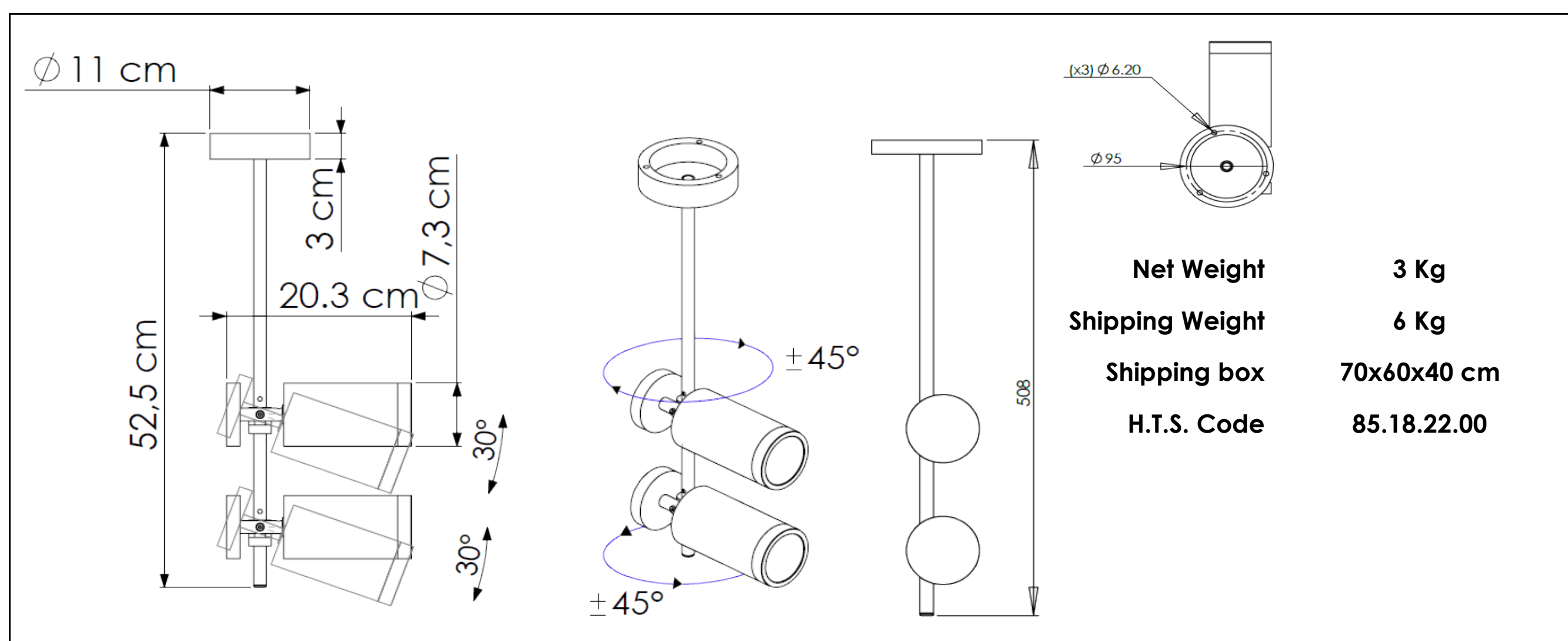

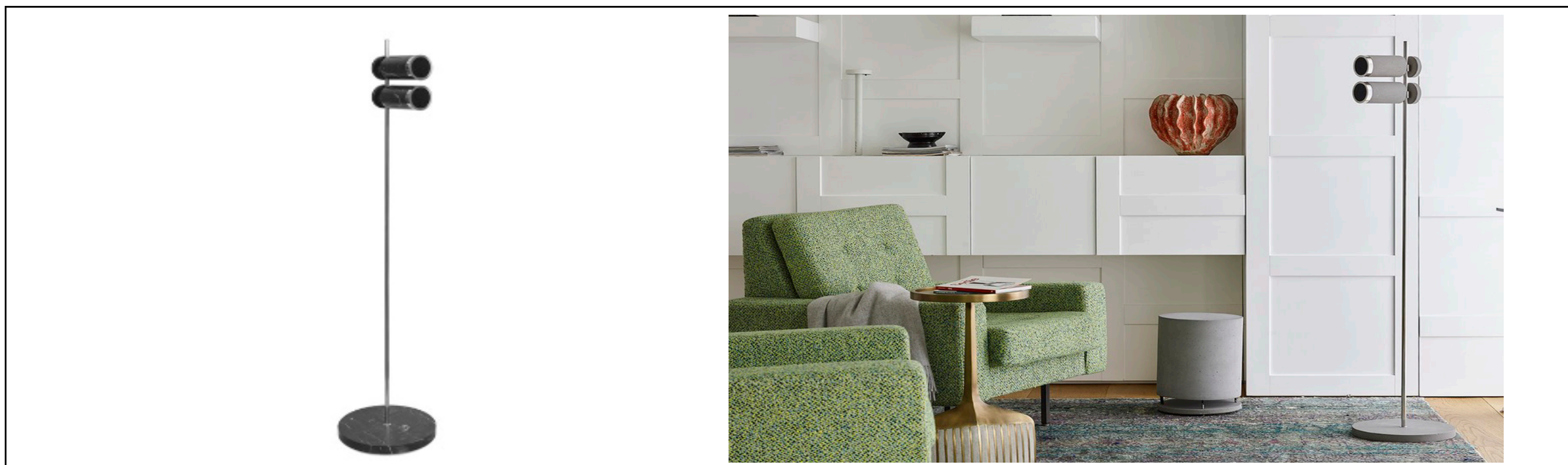

Standard version highlighted in red

*POLE+CAP+RING





ICARUS_MULTISTAND

REF CODE		CHF	UVP
ICAMLST-CN ICAMLST-CNP ICAMLST-CNW ICAMLST-CNR ICAMLST-CNB	 <p>ICARUS MULTISTAND_Concrete Without Crossover - Bodies in Concrete Metal parts in polished Steel 304 > see table on the next page See variations on Concrete palette at the end</p> <p> CN GREY CNP BLACK CNW WHITE CNR RED CNB OceanBlue </p>	 	2'150
ICAMLST-ST01 ICAMLST-ST02 ICAMLST-ST03 ICAMLST-ST04	 <p>ICARUS MULTISTAND_Basic Stones Without Crossover - Bodies in Basic Stone Metal parts in polished Steel 304 > see table on the next page See variations on Basic Stones palette at the end</p> <p> ST01 TRVC ST02 TRVW ST03 CARW ST04 MARQ </p>	 	4'400
ICAMLST-PM	 <p>ICARUS MULTISTAND_Premium Without Crossover - Bodies in Premium Stone Metal parts in polished Steel 304 > see table on the next page See variations on Premium Stones palette at the end</p>	 	POR





MAIN FUNCTIONAL OPTIONS

Please note that price for all the following options has to be added to the main model price

REF CODE		CHF	UVP
ICAMLST-HZ20	 <p>HIGH IMPEDANCE ON BOARD 70/100V - 20W</p>		75

CUSTOMIZATION & ACCESSORIES

Please note that price for all the following options and accessories has to be added to the main model price

REF CODE		CHF	UVP
ICAMLST-MTL-BLK	 <p>COVERS in MATT BLACK painted Steel 304 > see table on the next page</p>		220
ICAMLST-MTL-SAT	 <p>Metal parts in SATIN-finished Steel 304 > see table on the next page</p>		590
ICAMLST-MTL-POL316	 <p>Metal parts in POLISHED Steel 316L > see table on the next page</p>		1'100
ICAMLST-MTL-BRS	 <p>Metal parts in oxidized BRASS > see table on the next page</p>		830
PLAST-ICAMLST	Plaster treatment for travertines		225
POL-ICAMLST	Polishing treatment for all marbles		190
COVER-ICAMLST-B	PVC Basic Envelope		210

METAL FINISHES TABLE



VERSION	GRID	COVER	JOINT	WIRE	POLE*
STEEL 304 POLISHED	BLACK	304 POLISHED	304 POL	BLACK	304 POL
STEEL 304 SATIN	BLACK	304 SATIN	304 SAT	BLACK	304 POL
STEEL 316L POLISHED	BLACK	316L POLISHED	316 POL	BLACK	316L POL
STEEL 304 BLACK PAINT	BLACK	304 BLACK	304 POL	BLACK	304 POL
BRASS	BLACK	BRASS	BRASS	BLACK	BRASS





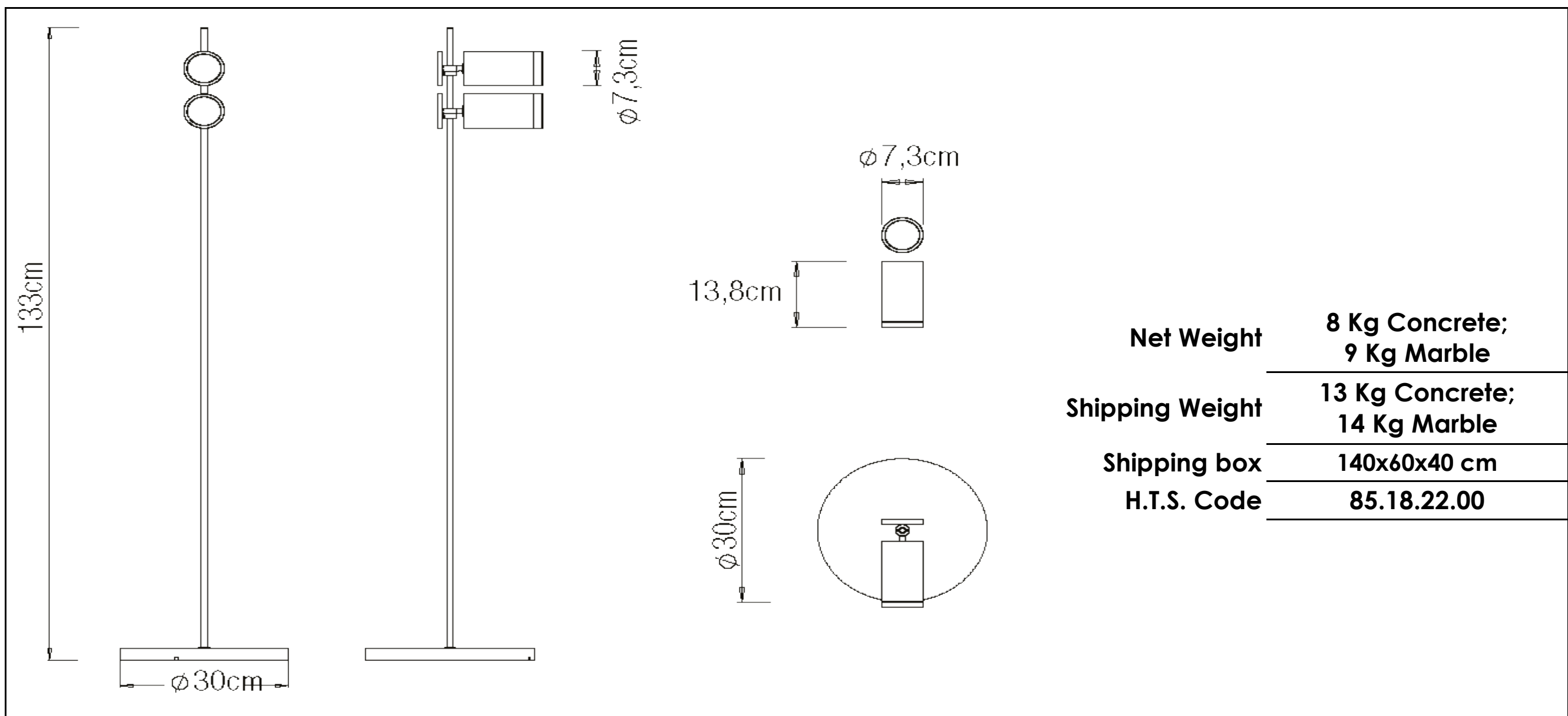

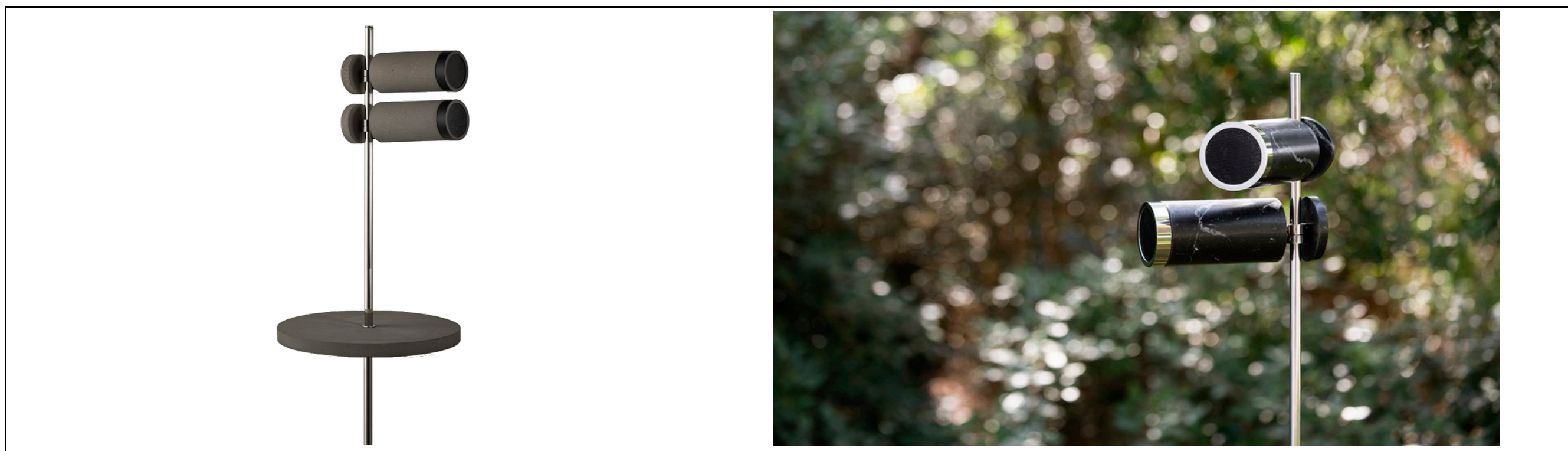

Standard version highlighted in red

*POLE+CAP+RING





ICARUS_MULTIGROUND

REF CODE		CHF	UVP
ICAMLGR-CN ICAMLGR-CNP ICAMLGR-CNW ICAMLGR-CNR ICAMLGR-CNB	 <p>ICARUS MULTIGROUND_Concrete Without Crossover - Bodies in Concrete Metal parts in polished Steel 304 > see table on the next page See variations on Concrete palette at the end</p> <p> CN GREY CNP BLACK CNW WHITE CNR RED CNB OceanBlue </p>	 	1'820
ICAMLGR-ST01 ICAMLGR-ST02 ICAMLGR-ST03 ICAMLGR-ST04	 <p>ICARUS MULTIGROUND_Basic Stones Without Crossover - Bodies in Basic Stone Metal parts in polished Steel 304 > see table on the next page See variations on Basic Stones palette at the end</p> <p> ST01 TRVC ST02 TRVW ST03 CARW ST04 MARQ </p>	 	3'250
ICAMLGR-PM	 <p>ICARUS MULTIGROUND_Premium Without Crossover - Bodies in Premium Stone Metal parts in polished Steel 304 > see table on the next page See variations on Premium Stones palette at the end</p>	 	POR





MAIN FUNCTIONAL OPTIONS

Please note that price for all the following options has to be added to the main model price

REF CODE		CHF	UVP
ICAMLGR-HZ20	 <p>HIGH IMPEDANCE ON BOARD 70/100V - 20W</p>		75

CUSTOMIZATION & ACCESSORIES

Please note that price for all the following options and accessories has to be added to the main model price

REF CODE		CHF	UVP
ICAMLGR-MTL-BLK	 <p>COVERS in MATT BLACK painted Steel 304 > see table on the next page</p>		220
ICAMLGR-MTL-SAT	 <p>Metal parts in SATIN-finished Steel 304 > see table on the next page</p>		590
ICAMLGR-MTL-POL316	 <p>Metal parts in POLISHED Steel 316L > see table on the next page</p>		1'100
ICAMLGR-MTL-BRS	 <p>Metal parts in oxidized BRASS > see table on the next page</p>		830
PLAST-ICAMLGR	Plaster treatment for travertines		115
POL-ICAMLGR	Polishing treatment for all marbles		95
COVER-ICAMLGR-B	PVC Basic Envelope		210

METAL FINISHES TABLE

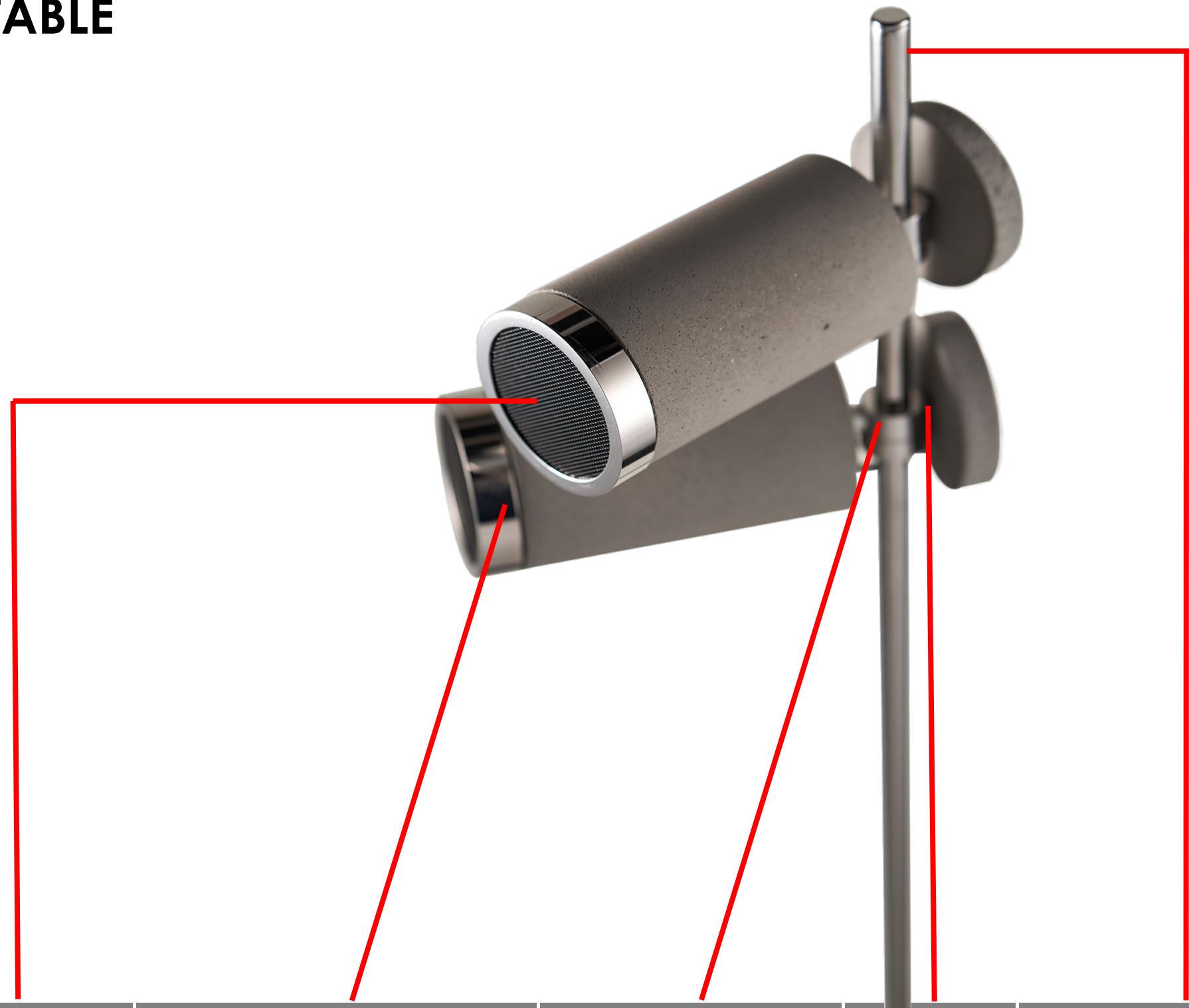

VERSION	GRID	COVER	JOINT	WIRE	POLE*
STEEL 304 POLISHED	BLACK	304 POLISHED	304 POL	BLACK	304 POL
STEEL 304 SATIN	BLACK	304 SATIN	304 SAT	BLACK	304 POL
STEEL 316L POLISHED	BLACK	316L POLISHED	316 POL	BLACK	316L POL
STEEL 304 BLACK PAINT	BLACK	304 BLACK	304 POL	BLACK	304 POL
BRASS	BLACK	BRASS	BRASS	BLACK	BRASS















Standard version highlighted in red

*POLE+CAP+RING

Net Weight	7 Kg
Shipping Weight	12 Kg
Shipping box	140x60x40 cm
H.T.S. Code	85.18.22.00







MEDIUM CYLINDER_450

REF CODE		CHF	UVP
MDCY-CN MDCY-CNP MDCY-CNW MDCY-CNR MDCY-CNB	 <p>Medium Cylinder_Concrete Aluminium black painted base See variations on Concrete palette at the end</p> <p>CN GREY CNP BLACK CNW WHITE CNR RED CNB OceanBlue</p>	 	1'650
MDCY-ST01 MDCY-ST02 MDCY-ST03 MDCY-ST04	 <p>Medium Cylinder_Basic Stones Aluminium black painted base See variations on Basic Stones palette at the end</p> <p>ST01 TRVC ST02 TRVW ST03 CARW ST04 MARQ</p>	 	3'250
MDCY-PM	 <p>Medium Cylinder_Premium Aluminium black painted base See variations on Premium Stones palette at the end</p>	 	POR
REF CODE		CHF	UVP Stk x2*
MDCY-PPCN MDCY-PPCNP MDCY-PPCNW MDCY-PPCNR MDCY-PPCNB	 <p>PAIR-PACK SOLUTION 2 Medium Cylinders_Concrete Aluminium black painted base See variations on Concrete palette at the end</p> <p>CN GREY CNP BLACK CNW WHITE CNR RED CNB OceanBlue</p>	 	3'090
MDCY-PPSS	 <p>PAIR-PACK SOLUTION 2 Medium Cylinders_Solid Surface Betacryl only white Aluminium black painted base</p>	 	3'480

*prices refer to nr. 2 units in a single carton box



MAIN FUNCTIONAL OPTIONS

Please note that price for all the following options has to be added to the main model price

REF CODE		CHF	UVP
MDCY-XBSUB	 SUB VERSION WITH CROSSOVER		190
MDCY-HZ30	 HIGH IMPEDANCE ON BOARD 70/100V - 30W		125
MDCY-HZ60	 HIGH IMPEDANCE ON BOARD 70/100V - 60W		160
MDCY-LM	 LIGHTING MOOD Led Strip in a notch around the loudspeaker area Supplied with (external) multivoltage power supply 3000 K - NO RGB		225

CUSTOMIZATION & ACCESSORIES

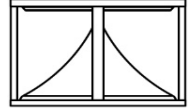
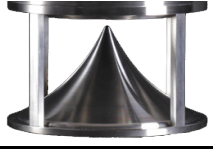
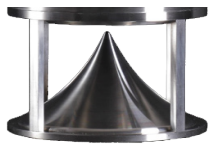
Please note that price for all following options and accessories has to be added to the main model price

BASE OPTIONS			
REF CODE		CHF	UVP
CYBS-RAL	 Aluminium base painted in ALL RAL colors		185
CYBS-SAT	 SATIN Steel 316L base		1'290
CY-POL	 POLISHED Steel 316L base		1'290
CYBS-BRS	 Oxidised BRASS base		1'390

OTHER ACCESSORIES

REF CODE		CHF	UVP
PLAST450	Plaster treatment for travertines		280
POL450	Polishing treatment for marbles		250
AF-CY-VER	Anti-theft for Grass land*		150
SP-MDCY-VER	Sand proof system		75
COVER-MDCY-B	PVC Basic Envelope		110

* Hard floor Anti-theft system is also available (info on request)

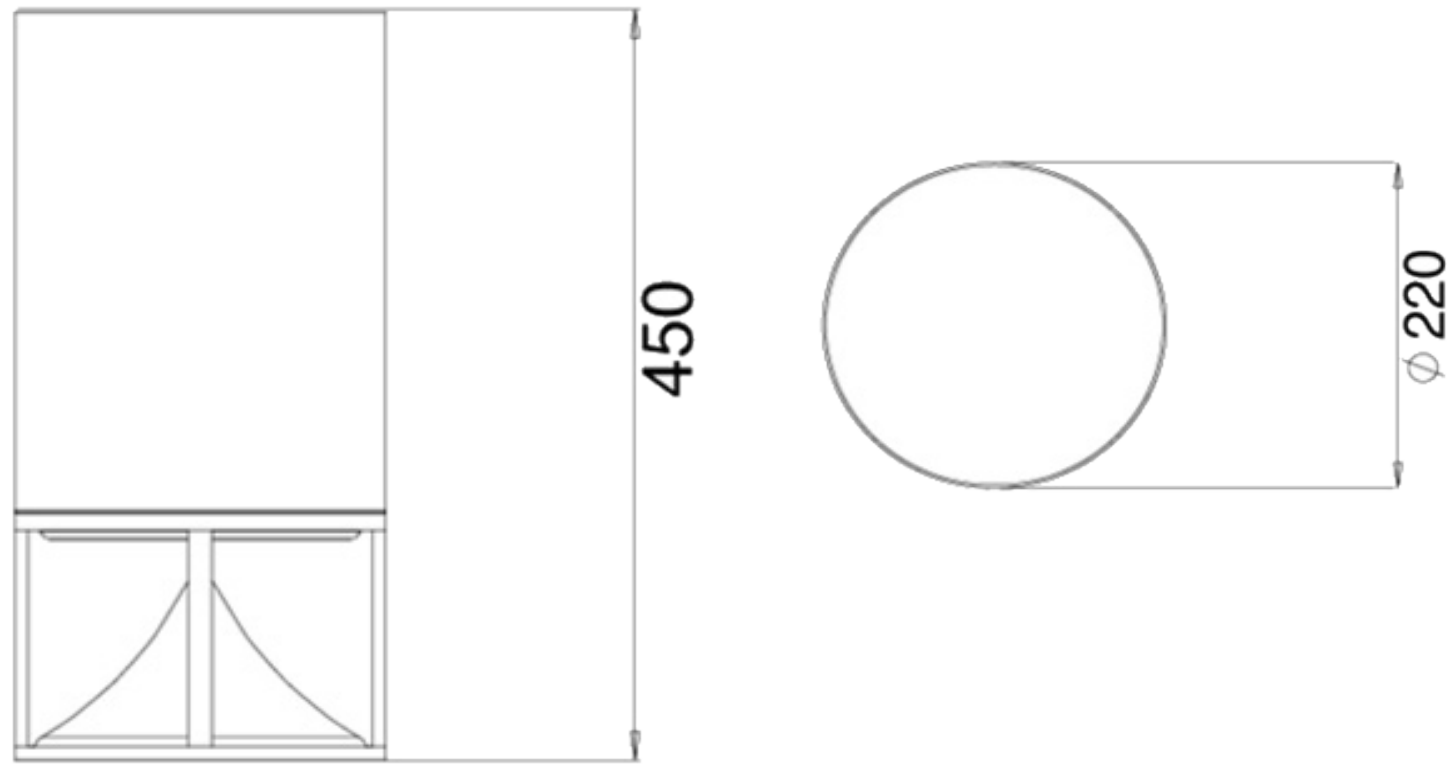
	Net Weight	21 Kg Concrete; 23 Kg Marble; 19 Kg S. Surface; 48 Kg PAIR-PACK
	Shipping Weight	23 Kg Concrete; 25 Kg Marble; 20 Kg S. Surface; 50 Kg PAIR-PACK
	Shipping box	41x41x55.5 cm; 36x63x55.5 cm Pair-Pack
	H.T.S. Code	85.18.21.00



TALL CYLINDER_550

REF CODE		CHF	UVP
TLCY-CN TLCY-CNP TLCY-CNW TLCY-CNR TLCY-CNB	<p>Tall Cylinder_Concrete Aluminium black painted base See variations on Concrete palette at the end</p> <p> CN GREY CNP BLACK CNW WHITE CNR RED CNB OceanBlue </p>	 	1'850
TLCY-ST01 TLCY-ST02 TLCY-ST03 TLCY-ST04	<p>Tall Cylinder_Basic Stones Aluminium black painted base See variations on Basic Stones palette at the end</p> <p> ST01 TRVC ST02 TRVW ST03 CARW ST04 MARG </p>	 	3'500
TLCY-PM	<p>Medium Cylinder_Premium Aluminium black painted base See variations on Premium Stones palette at the end</p>	 	POR
TLCY-PPCN TLCY-PPCNP TLCY-PPCNW TLCY-PPCNR TLCY-PPCNB	<p>PAIR-PACK SOLUTION 2 Tall Cylinders_Concrete Aluminium black painted base See variations on Concrete palette at the end</p> <p> CN GREY CNP BLACK CNW WHITE CNR RED CNB OceanBlue </p>	 	3'450

*prices refer to nr. 2 units in a single carton box

MAIN FUNCTIONAL OPTIONS



Please note that price for all the following options has to be added to the main model price

REF CODE		CHF	UVP
TLCY-XBSUB	<p>SUB VERSION WITH CROSSOVER</p>		190
TLCY-HZ30	<p>HIGH IMPEDANCE ON BOARD 70/100V - 30W</p>		125
TLCY-HZ60	<p>HIGH IMPEDANCE ON BOARD 70/100V - 60W</p>		160
TLCY-LM	<p>LIGHTING MOOD Led Strip in a notch around the loudspeaker area Supplied with (external) multivoltage power supply 3000 K - NO RGB</p>		225

CUSTOMIZATION & ACCESSORIES

Please note that price for all following options and accessories has to be added to the main model price

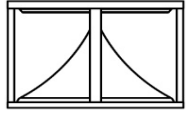
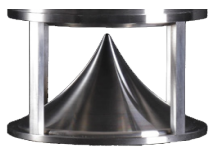
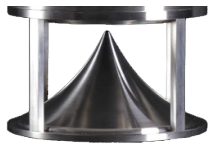
BASE OPTIONS

REF CODE		CHF	UVP
CYBS-RAL	 Aluminium base painted in ALL RAL colors		185
CYBS-SAT	 SATIN Steel 316L base		1'290
CY-POL	 POLISHED Steel 316L base		1'290
CYBS-BRS	 Oxidised BRASS base		1'390

OTHER ACCESSORIES

REF CODE		CHF	UVP
PLAST450	Plaster treatment for travertines		280
POL450	Polishing treatment for marbles		250
AF-CY-VER	Anti-theft for Grass land*		150
SP-TLCY-VER	Sand proof system		75
COVER-TLCY-B	PVC Basic Envelope		110

* Hard floor Anti-theft system is also available (info on request)

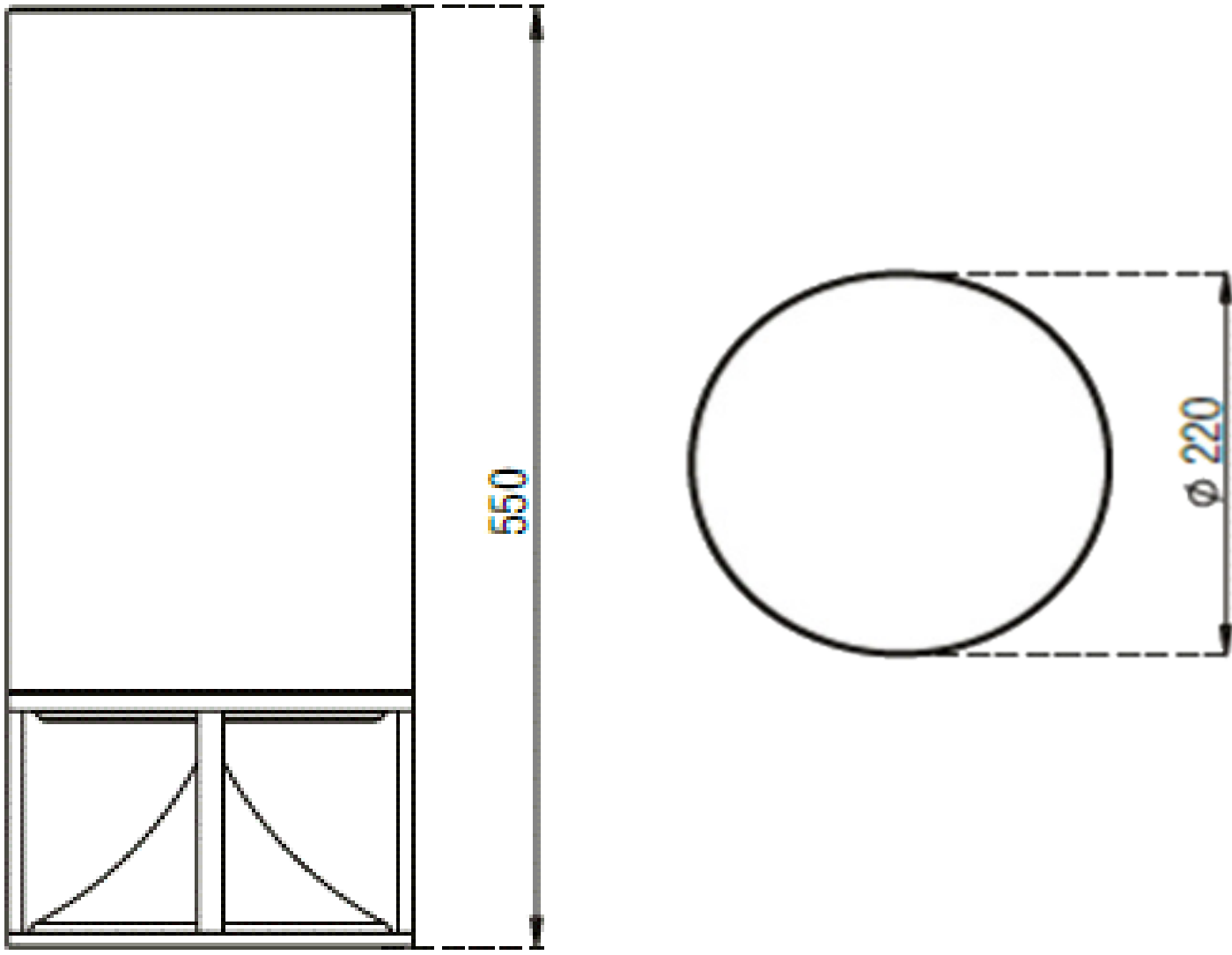
	Net Weight	23 Kg Concrete; 25 Kg Marble; 53 Kg PAIR-PACK
	Shipping Weight	25 Kg Concrete 27 Kg Marble; 21 Kg S. Surface; 55 Kg PAIR-PACK
	Shipping box	41x41x66.5 cm; 36x63x67 cm Pair-Pack
	H.T.S. Code	85.18.21.00

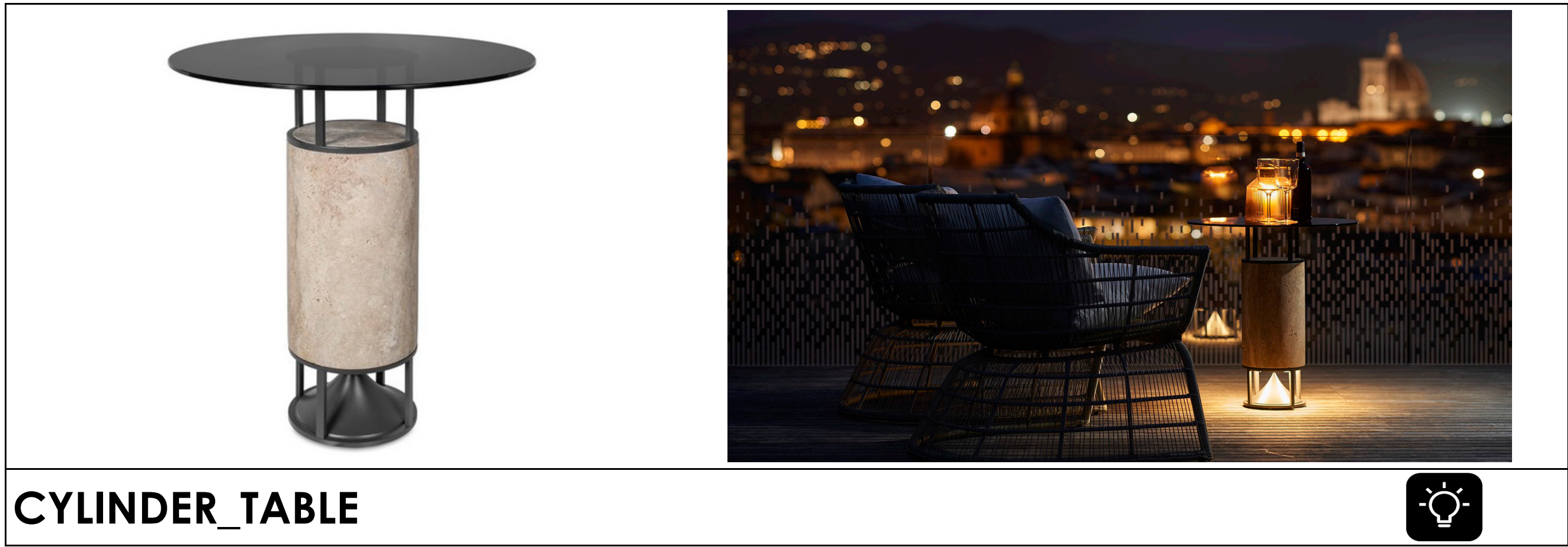

CYLINDER_TABLE









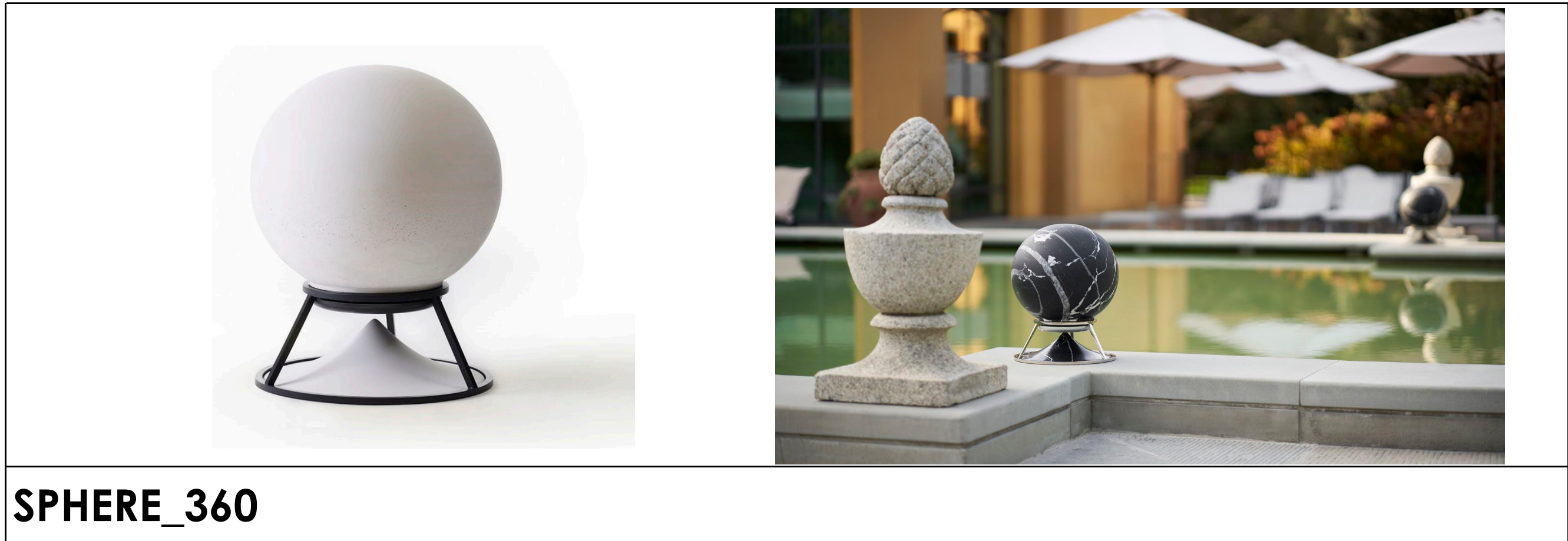





REF CODE		CHF	UVP
TABCYL-CN TABCYL-CNP TABCYL-CNW TABCYL-CNR TABCYL-CNB	 Cylinder Table_Concrete Aluminium black painted base Clear or smoked glass Table Lighting led strip included (3000 K -NO RGB) See variations on Concrete palette at the end 	 	3'490
TABCYL-ST01 TABCYL-ST02 TABCYL-ST03 TABCYL-ST04	 Cylinder Table_Basic Stones Aluminium black painted base Clear or smoked glass Table Lighting led strip included (3000 K - NO RGB) See variations on Basic Stones palette at the end	 	5'690
TABCYL-PM	 Cylinder_Premium Stones Aluminium black painted base Clear or smoked glass Table Lighting led strip included (3000 K - NO RGB) See variations on Premium Stones palette at the end	 	POR

MAIN FUNCTIONAL OPTIONS			
Please note that price for all the following options has to be added to the main model price			
REF CODE		CHF	UVP
TLCY-XBSUB	SUB VERSION WITH CROSSOVER		190
TLCY-HZ30	HIGH IMPEDANCE ON BOARD 70/100V - 30W		125
TLCY-HZ60	HIGH IMPEDANCE ON BOARD 70/100V - 60W		160

Net Weight	31 Kg Concrete; 33 Kg Marble
Shipping Weight	33 Kg Concrete; 35 Kg Marble
Shipping Box (1 box + glass plate packaging)	38x88x39cm (box) 60x60x5cm
H.T.S. CODE	85.18.21.00







SPHERE_360

REF CODE		CHF	UVP
SF360-CN SF360-CNP SF360-CNW SF360-CNR SF360-CNB	 <p>Sphere 360_Concrete Brass black painted base See variations on Concrete palette at the end</p> <p> CN GREY CNP BLACK CNW WHITE CNR RED CNB OceanBlue </p>	 	2'660
SF360-TC	 <p>Sphere 360_Terracotta Brass black painted base See variations on Terracotta palette at the end</p> <p>TC TERR</p>	 	2'660
SF360-ST01 SF360-ST02 SF360-ST03 SF360-ST04	 <p>Sphere 360_Basic Stones Brass black painted base See variations on Basic Stones palette at the end</p> <p> ST01 TRVC ST02 TRVW ST03 CARW ST04 MARQ </p>	 	5'450
SF360-PM	 <p>Sphere 360_Premium Brass black painted base See variations on Premium Stones palette at the end</p>	 	POR

MAIN FUNCTIONAL OPTIONS





Please note that price for all the following options has to be added to the main model price

REF CODE		CHF	UVP
SF360-XBSUB	 <p>SUB VERSION WITH CROSSOVER</p>		190
SF360-HZ30	 <p>HIGH IMPEDANCE ON BOARD 70/100V - 30W</p>		110
SF360-HZ60	 <p>HIGH IMPEDANCE ON BOARD 70/100V - 60W</p>		140
SF360-LM	 <p>LIGHTING MOOD Led Strip in a notch around the loudspeaker area Supplied with (external) multivoltage power supply 3000 K - NO RGB</p>		270

CUSTOMIZATION & ACCESSORIES

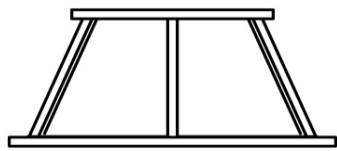
Please note that price for all following options and accessories has to be added to the main model price

BASE OPTIONS

REF CODE		CHF	UVP
SFBS-RAL	 Three-leg brass base painted in ALL RAL colors		400
SFBS-SAT	 Three-leg Steel 316L base, SATIN finishing		650
SFBS-POL	 Three-leg Steel 316L base, POLISHED finishing		650
SFBS-BRS	 Three-leg oxidised BRASS base		460
SF-SLOT	SLOT on MARBLE Deflector		280

OTHER ACCESSORIES

REF CODE		CHF	UVP
PLAST360	Plaster Treatment for Travertines 360mm		300
POL360	Polishing treatment for marbles		250
VHGRS-SF-VER	Anti-theft for Grass land		380
VHFLR-SF-VER	Anti-theft for Hard floor		270
SP-360-VER	Sand proof System		75
COVER-SF360-B	PVC Basic Envelope		150
COVER-SF360-P	PVC Premium Cover		380

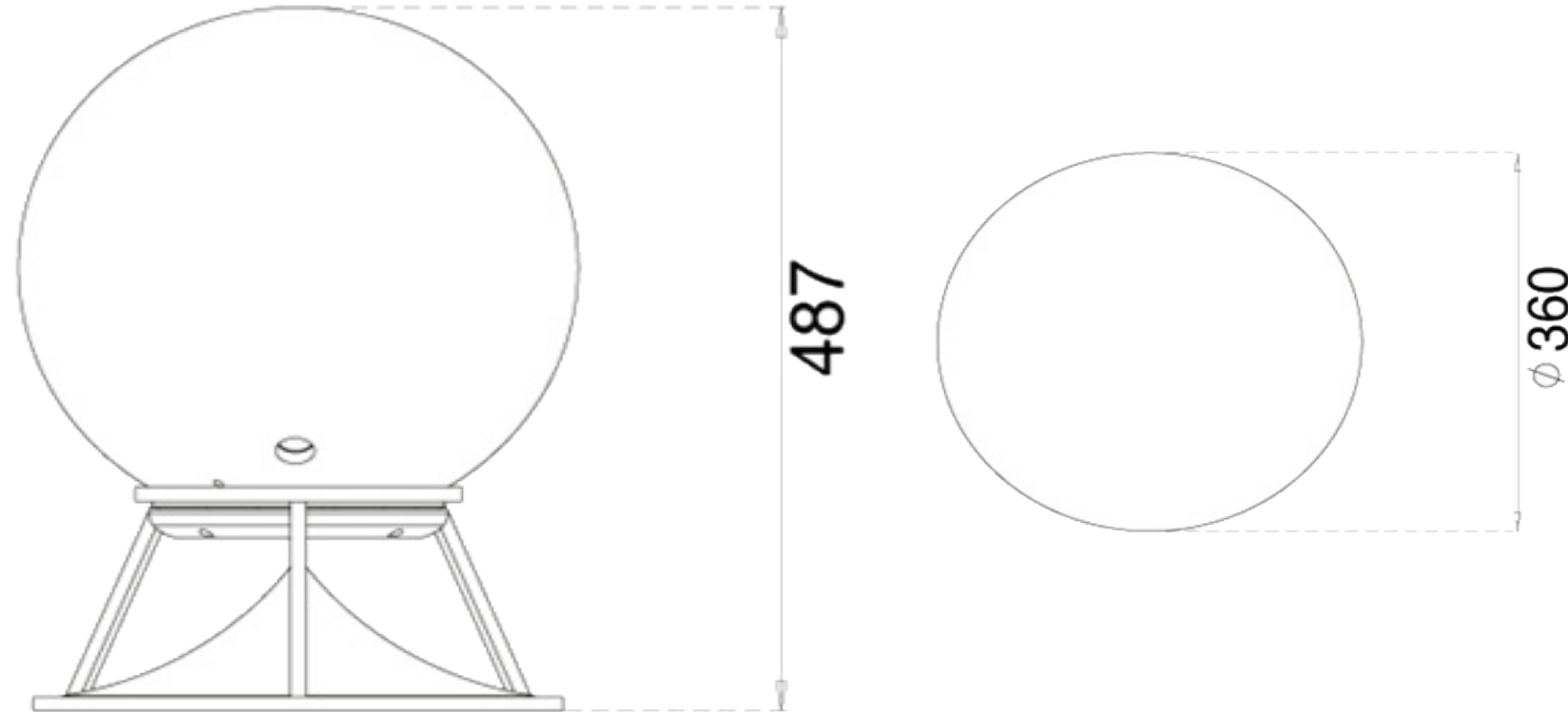
	Net Weight	24 Kg Concrete; 25 Kg Marble; 15 Kg Terracotta
	Shipping Weight	26 Kg Concrete; 27.5 Kg Marble; 18.5 Kg Terracotta
	Shipping box	49x48x75.5 cm
	H.T.S. Code	85.18.21.00



SPHERE_470

REF CODE			CHF	UVP
SF470-ST01		<p>Sphere 470_Basic Stones Brass black painted base See variations on Basic Stones palette at the end</p> <p>ST01 TRVC ST02 TRVW ST03 CARW ST04 MARQ </p>	 	POR POR
SF470-ST02				
SF470-ST03				
SF470-ST04				
SF470-PM		<p>Sphere 470_Premium Brass black painted base See variations on Premium Stones palette at the end</p>	 	POR POR

MAIN FUNCTIONAL OPTIONS

Please note that price for all the following options has to be added to the main model price

REF CODE		CHF	UVP
SF470-XBSUB	<p>SUB VERSION WITH CROSSOVER</p>		190
SF470-HZ30	<p>HIGH IMPEDANCE ON BOARD 70/100V - 30W</p> <p>HIGH IMPEDANCE ON BOARD 70/100V - 60W</p>		110
SF470-HZ60			140
SF470-LM	<p>LIGHTING MOOD Led Strip in a notch around the loudspeaker area Supplied with (external) multivoltage power supply 3000 K - NO RGB</p>		270

CUSTOMIZATION & ACCESSORIES

Please note that price for all following options and accessories has to be added to the main model price

BASE OPTIONS

REF CODE		CHF	UVP
SFBS-RAL	<p>Three-leg brass base painted in ALL RAL colors</p>		400
SFBS-SAT	<p>Three-leg Steel 316L base, SATIN finishing</p>		650
SFBS-POL	<p>Three-leg Steel 316L base, POLISHED finishing</p>		650
SFBS-BRS	<p>Three-leg oxidised BRASS base</p>		460
SF-SLOT	SLOT on MARBLE Deflector		280

OTHER ACCESSORIES

REF CODE		CHF	UVP
PLAST470	Plaster Treatment for Travertines 360mm		300
POL470	Polishing treatment for marbles		250
VHGRS-SF-VER	Anti-theft for Grass land		380
VHFLR-SF-VER	Anti-theft for Hard floor		270
SP-470-VER	Sand proof System		75
COVER-SF470-B	PVC Basic Envelope		150
COVER-SF470-P	PVC Premium Cover		380

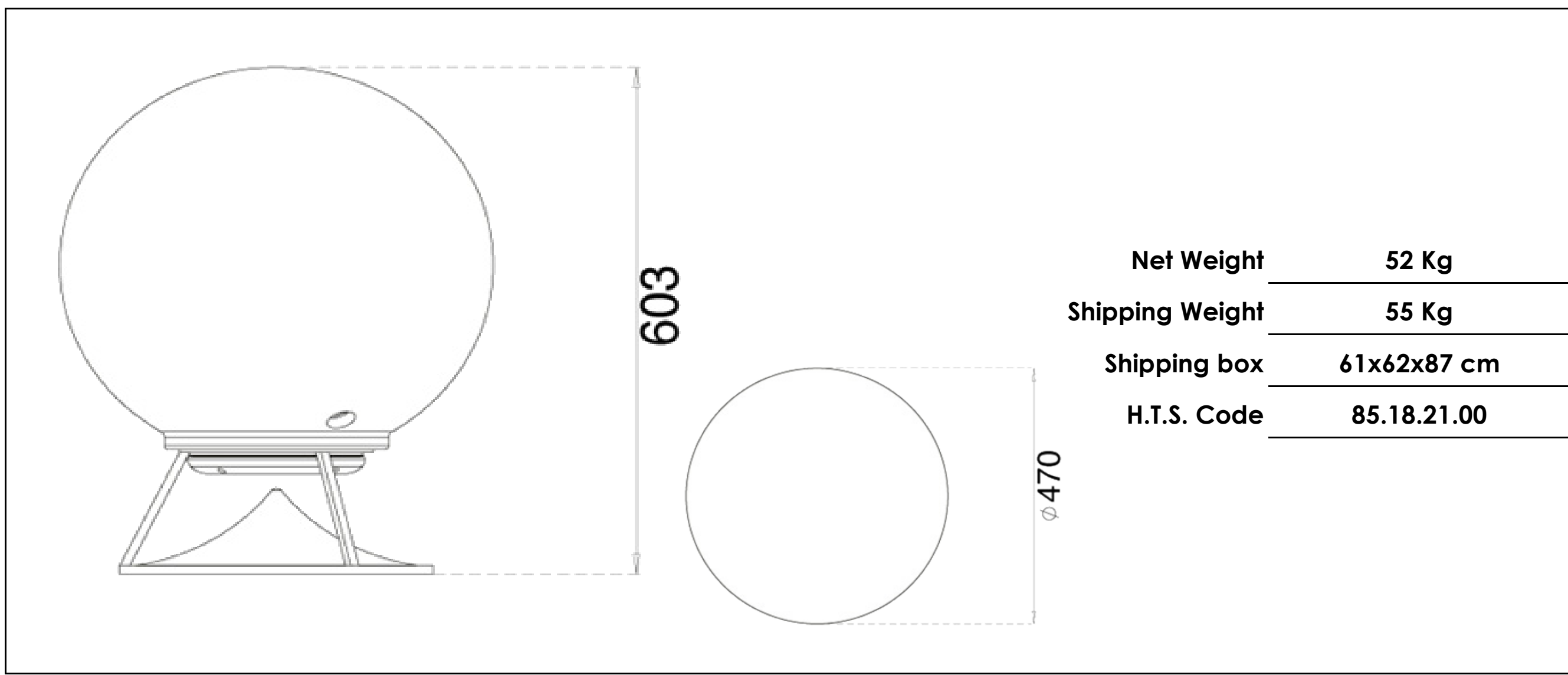

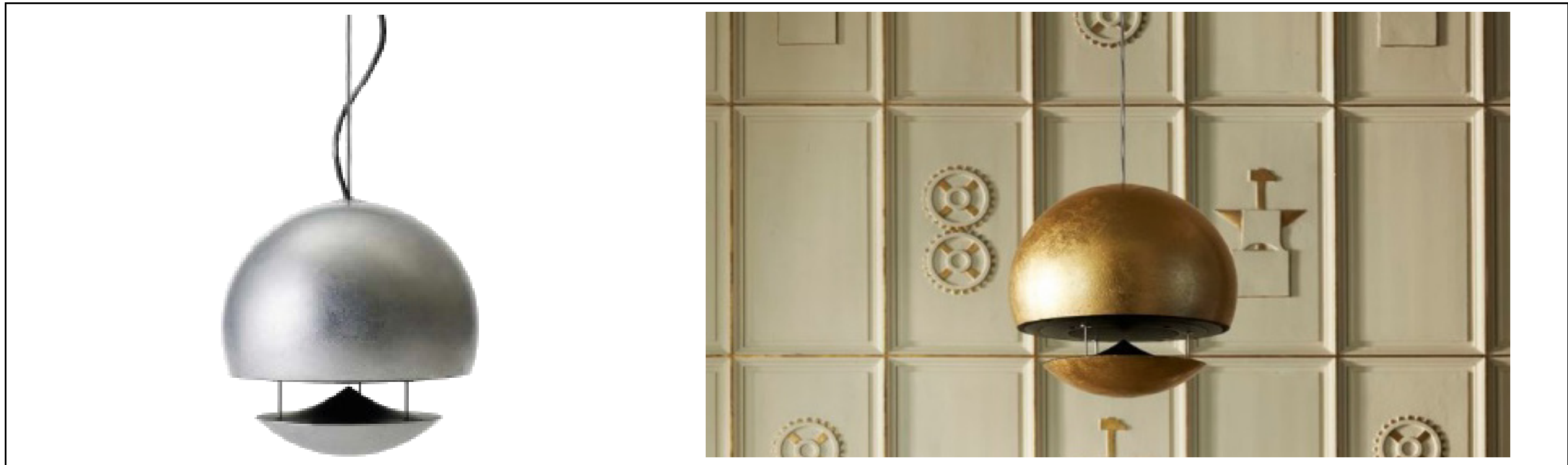

SPHERINA_AIR

REF CODE		CHF	UVP
SF3000-AIRC� SF3000-AIRCNP SF3000-AIRC�W SF3000-AIRCNR SF3000-AIRC�B	<p>Spherina Air_Concrete Stainless Steel bars See variations on Concrete palette at the end</p> <p> CN GREY CNP BLACK CNW WHITE CNR RED CNB OceanBlue </p>	 	2'150
SF3000-AIRST01 SF3000-AIRST02 SF3000-AIRST03 SF3000-AIRST04	<p>Spherina Air_Basic Stones Stainless Steel bars See variations on Basic Stones palette at the end</p> <p> ST01 TRVC ST02 TRVW ST03 CARW ST04 MARQ </p>	 	4'490
SF300-AIRPM	<p>Spherina Air_Premium Stainless Steel bars See variations on Premium Stones palette at the end</p>	 	POR
SF300-AIRGLD SF300-AIRSLV SF300-AIRCPR SF300-AIRBRZ	<p>Spherina Air_Shine Line Black Concrete body covered with either Gold, Silver or Copper leaves (only body and lower part of deflector) Stainless Steel bars See variations on Shine-Line palette at the end</p> <p> GLD Gold SLV Silver CPR Copper BRZ Bronze </p>	 	3'680
REF CODE		CHF	UVP Stk x2*
SF300-PPAIRC� SF300-PPAIRCNP SF300-PPAIRC�W SF300-PPAIRCNR SF300-PPAIRC�B	<p>PAIR-PACK SOLUTION 2 Spherinas Air_Concrete Stainless Steel bars See variations on Concrete palette at the end</p> <p> CN GREY CNP BLACK CNW WHITE CNR RED CNB OceanBlue </p>	 	4'050

*prices refer to nr. 2 units in a single carton box

ALL ABOVE MENTIONED MODELS ARE PRICED CONSIDERING THE FOLLOWING FEATURES

The hanging steel cable is the perfect solution to mount the speaker by using a really sleek system, which combines the supporting steel and the audio and light cable.

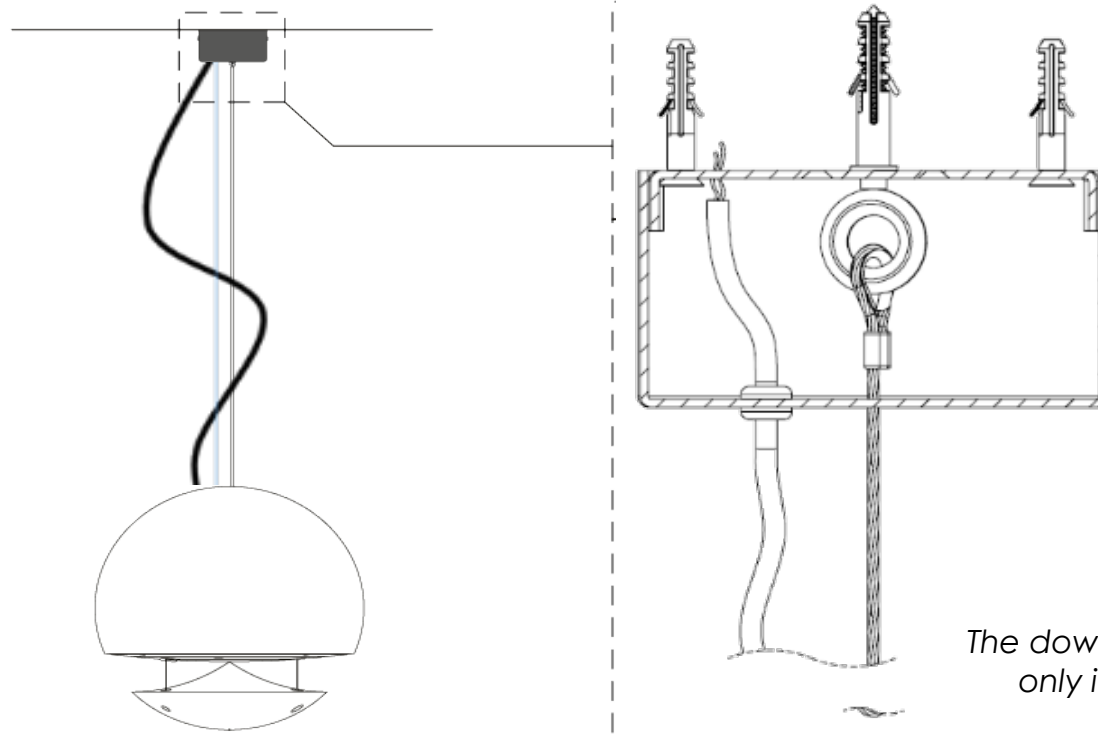

The Hanging Steel Cable system



The hanging steel cable is supplied with the Ceiling Rose (matt black is the standard version), which allows you to hang the loudspeaker like a standard suspended lamp (see drawing here).

MAIN FUNCTIONAL OPTIONS

Please note that price for all the following options has to be added to the main model price

REF CODE		CHF	UVP
SF300-AIR-XBSUB	 SUB VERSION WITH CROSSOVER		190
SF300-LM	 LIGHTING MOOD Led Strip in a notch around the loudspeaker area Supplied with (external) multivoltage power supply 3000 K - NO RGB		250

CUSTOMIZATION & ACCESSORIES

Please note that price for all options and accessories has to be added to the main model price

ACCESSORIES



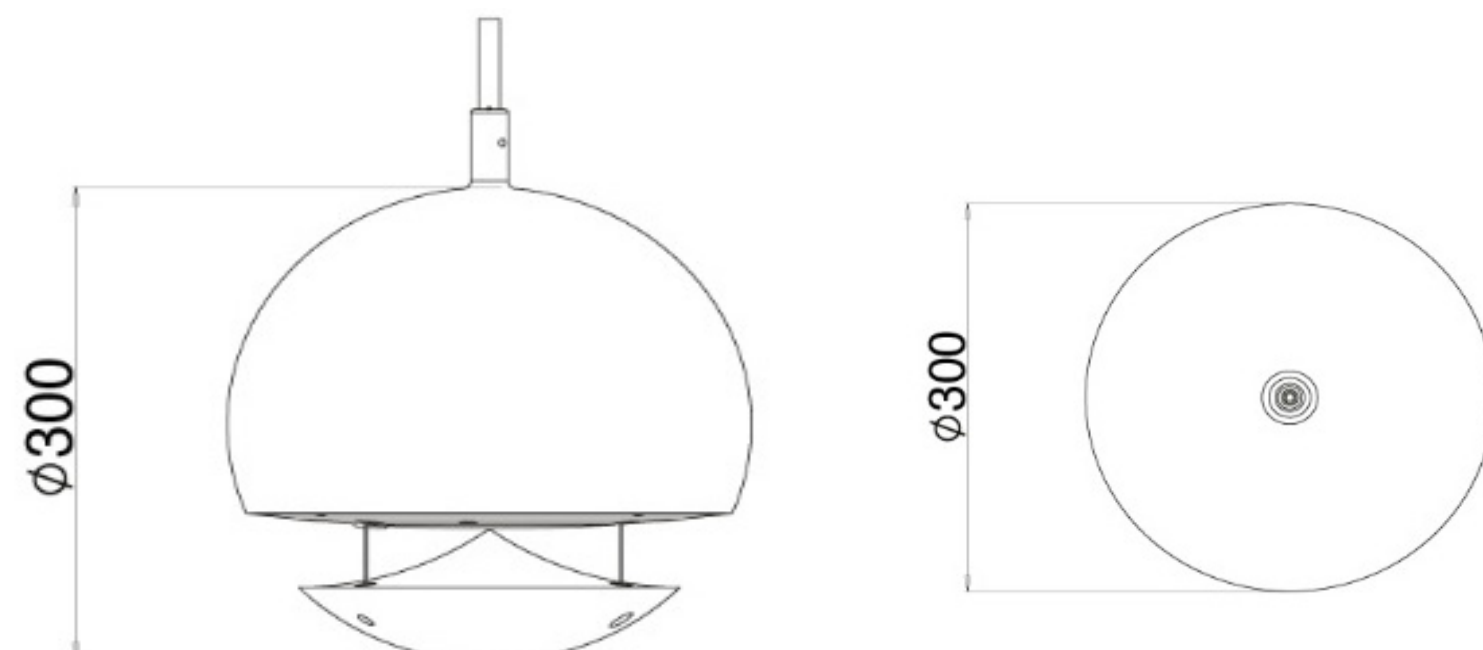

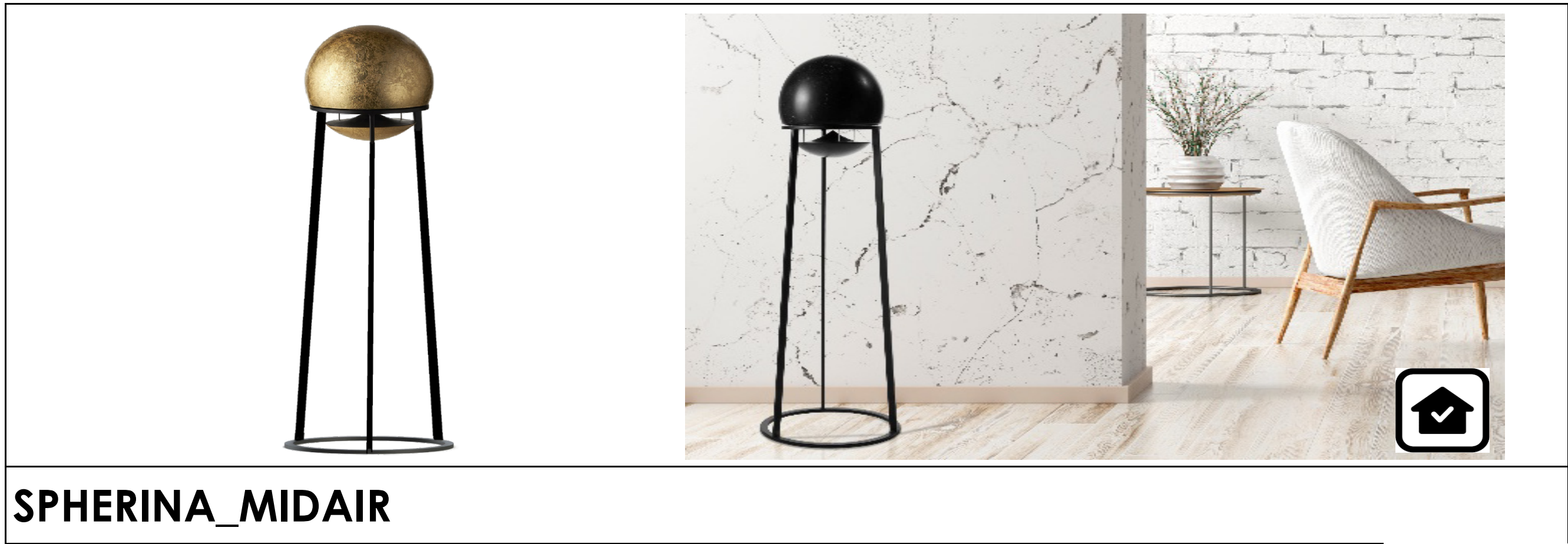

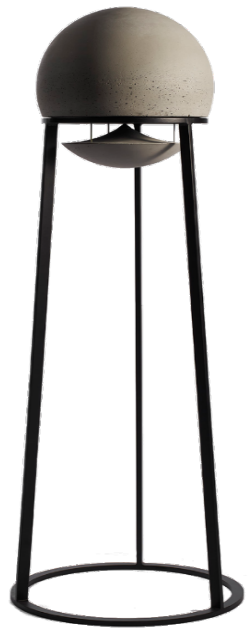

REF CODE		CHF	UVP
RSW	 Ceiling Rose - Matt White version		30
AF-SF300-VER	Anti-theft for Grass land		125
SP-SF300-VER	Sand proof system		170
COVER-SF300-B	PVC Basic Envelope		95
COVER-SF300-P	PVC Premium Cover		250

	Net Weight	15 Kg Concrete; 16.5 Kg Marble
	Shipping Weight	17 Kg Concrete; 18.5 Kg Marble
	Shipping box	40x40x40 cm; 42x79x39 cm Pair-Pack
	H.T.S. Code	85.18.21.00

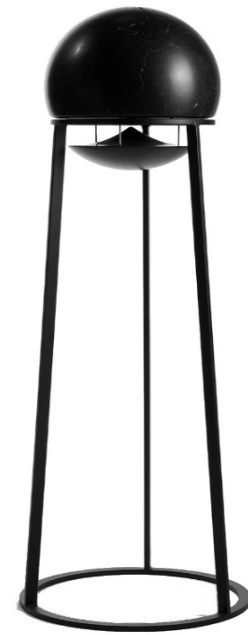

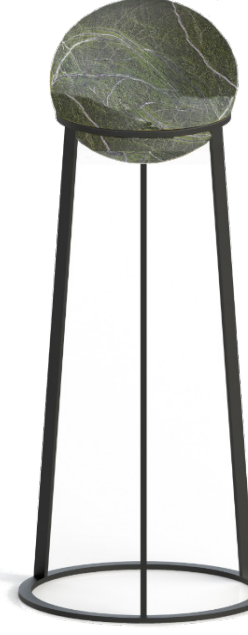

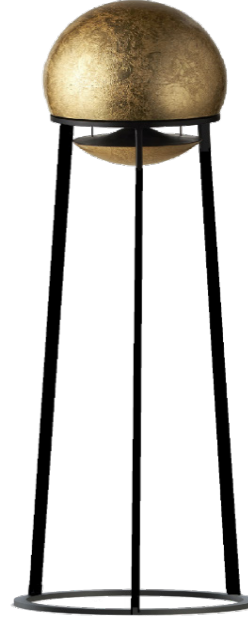
SPHERINA_MIDAIR

only indoors

REF CODE		CHF	UVP
SF3000-MIDCN SF3000-MIDCNP SF3000-MIDCNW SF3000-MIDCNR SF3000-MIDCNB	 <p>Spherina Mid-Air_Concrete Body in Concrete Matt Black painted metal Stand</p> <p>Only for indoor use See variations on Concrete palette at the end</p> <p> CN GREY CNP BLACK CNW WHITE CNR RED CNB OceanBlue </p>	 	2'950
SF3000-MIDST01 SF3000-MIDST02 SF3000-MIDST03 SF3000-MIDST04	 <p>Spherina Mid-Air_Basic Stones Body and base in Basic Stones Matt Black painted metal Stand</p> <p>Only for indoor use See variations on Premium Stones palette at the end</p> <p> ST01 TRVC ST02 TRVW ST03 CARW ST04 MARQ </p>	 	5'590
SF300-MID-PM	 <p>Spherina Mid-Air_Premium Body and base in Premium Stones Matt Black painted metal Stand</p> <p>Only for indoor use See variations on Premium Stones palette at the end</p>	 	POR
SF300-MIDGLD SF300-MIDSLV SF300-MIDCPR SF300-MIDBRZ	 <p>Spherina Air_Shine Line Black Concrete body covered with either Gold, Silver or Copper leafs (only body and lower part of deflector) Matt Black painted metal Stand</p> <p>Only for indoor use See variations on Shine-Line palette at the end</p> <p> GLD Gold SLV Silver CPR Copper BRZ Bronze </p>	 	4'590

MAIN FUNCTIONAL OPTIONS

Please note that price for all the following options has to be added to the main model price



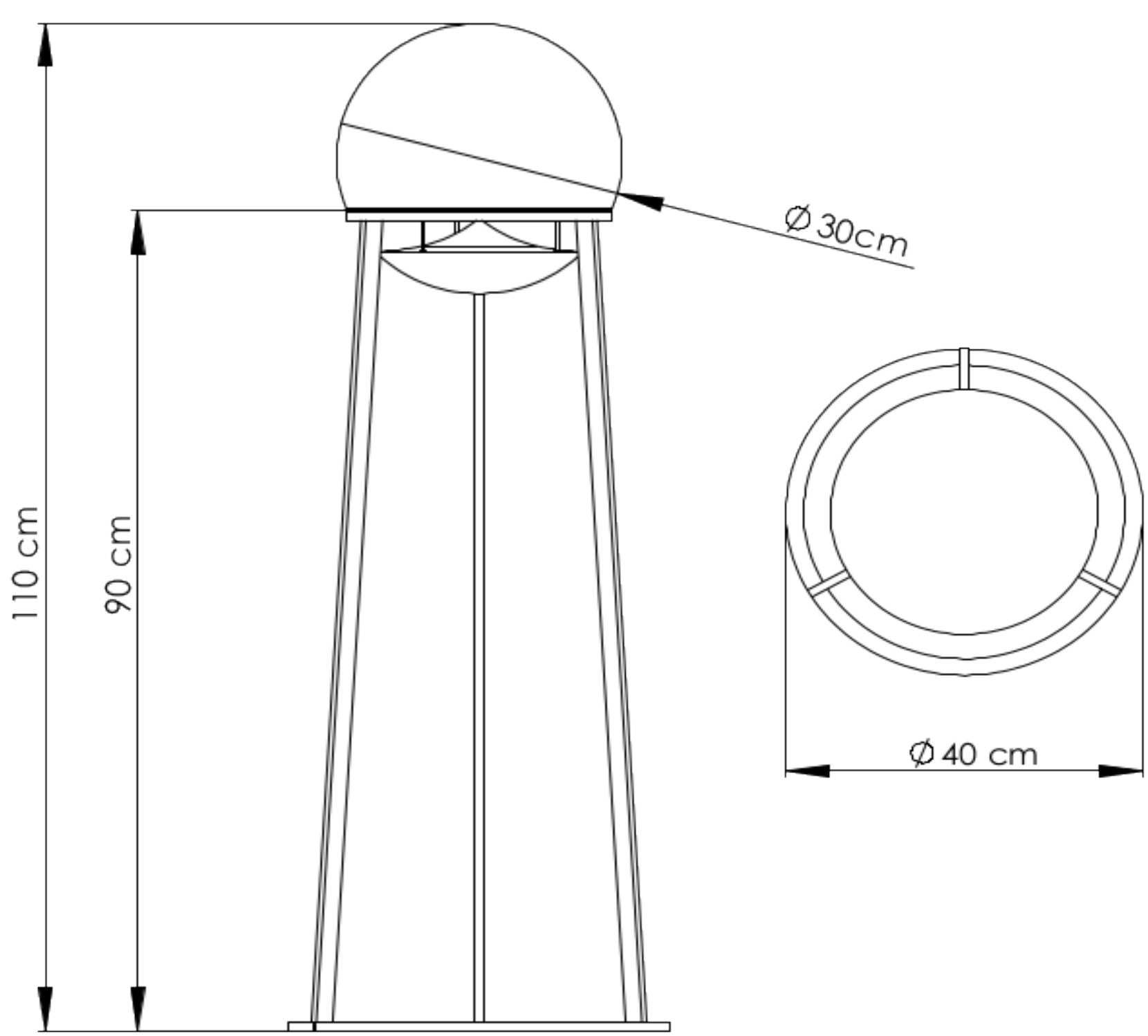



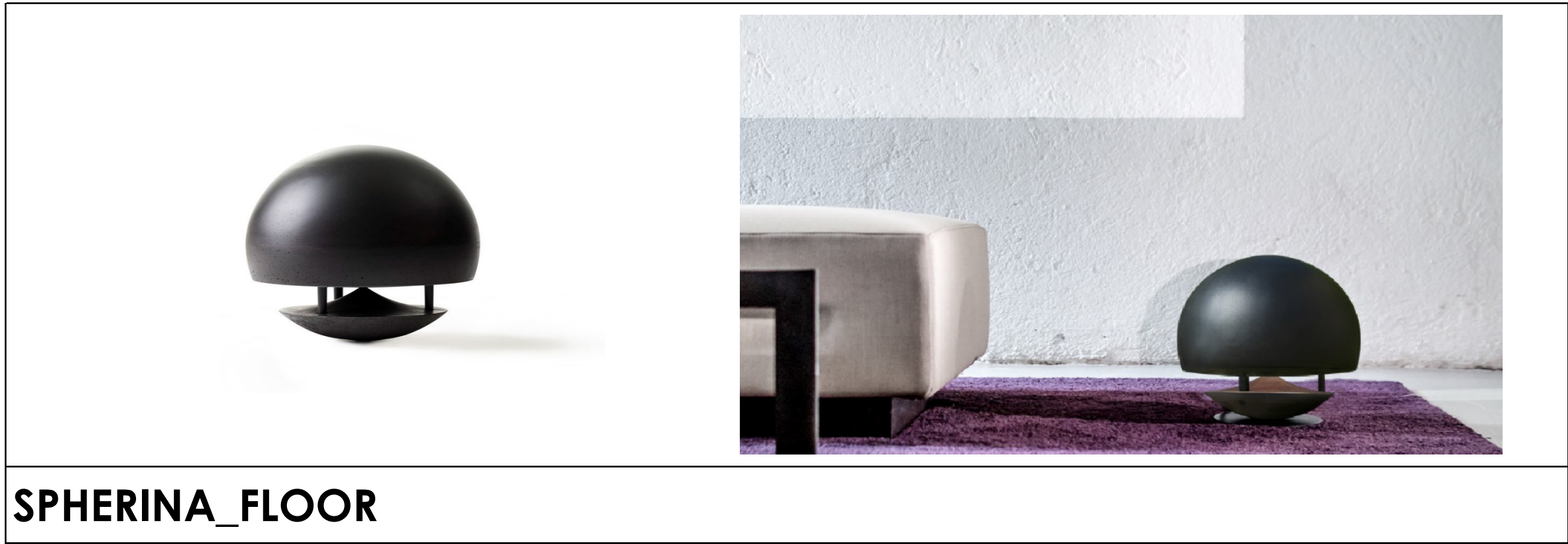







REF CODE		CHF	UVP
SF300-MID-XBSUB	 SUB VERSION WITH CROSSOVER		190
SF300-MID-LM	 LIGHTING MOOD Led Strip in a notch around the loudspeaker area Supplied with (external) multivoltage power supply 3000 K - NO RGB		250



Net Weight	19 Kg Concrete; 21 Kg Marble
Shipping Weight	22 Kg Concrete; 24 Kg Marble
Shipping boxes (2 boxes)	40x40x40 cm 40x40x100 cm
H.T.S. Code	85.18.21.00



SPHERINA_FLOOR

REF CODE		CHF	UVP
SF3000-FLRCN SF3000-FLRCNP SF3000-FLRCNW SF3000-FLRCNR SF3000-FLRCNB	 <p>Spherina Floor_Concrete Aluminium black painted legs See variations on Concrete palette at the end</p> <p> CN GREY CNP BLACK CNW WHITE CNR RED CNB OceanBlue </p>	 	1'890
SF3000-FLRST01 SF3000-FLRST02 SF3000-FLRST03 SF3000-FLRST04	 <p>Spherina Floor_Basic Stones Aluminium black painted legs See variations on Basic Stones palette at the end</p> <p> ST01 TRVC ST02 TRVW ST03 CARW ST04 MARQ </p>	 	4'350
SF300-FLR-PM	 <p>Spherina Floor_Premium Aluminium black painted legs See variations on Premium Stones palette at the end</p>	 	POR
SF300-FLRGLD SF300-FLRSLV SF300-FLRCPR SF300-FLRBRZ	 <p>Spherina Floor_Shine Line Black Concrete body covered with either Gold, Silver or Copper leaves (only body and lower part of deflector) Aluminium black painted legs Only for indoor use See variations on Shine-Line palette at the end</p> <p> GLD Gold SLV Silver CPR Copper BRZ Bronze </p>	 	3'300
SF300-PPFLRCN SF300-PPFLRCNP SF300-PPFLRCNW SF300-PPFLRCNR SF300-PPFLRCNB	 <p>PAIR-PACK SOLUTION 2 Spherinas Floor_Concrete Aluminium black painted legs See variations on Concrete palette at the end</p> <p> CN GREY CNP BLACK CNW WHITE CNR RED CNB OceanBlue </p>	 	3'590

*prices refer to nr. 2 units in a single carton box

MAIN FUNCTIONAL OPTIONS

Please note that price for all the following options has to be added to the main model price

REF CODE		CHF	UVP
SF300-FLR-XBSUB	 SUB VERSION WITH CROSSOVER		190

CUSTOMIZATION & ACCESSORIES

Please note that price for all options and accessories has to be added to the main model price

ACCESSORIES

REF CODE		CHF	UVP
AF-SF300-VER	Anti-theft for Grass land		125
SP-SF300-VER	Sand proof system		170
COVER-SF300-B	PVC Basic Envelope		95
COVER-SF300-P	PVC Premium Cover		250
PLX-DISC	Plaxiglass Disc		20

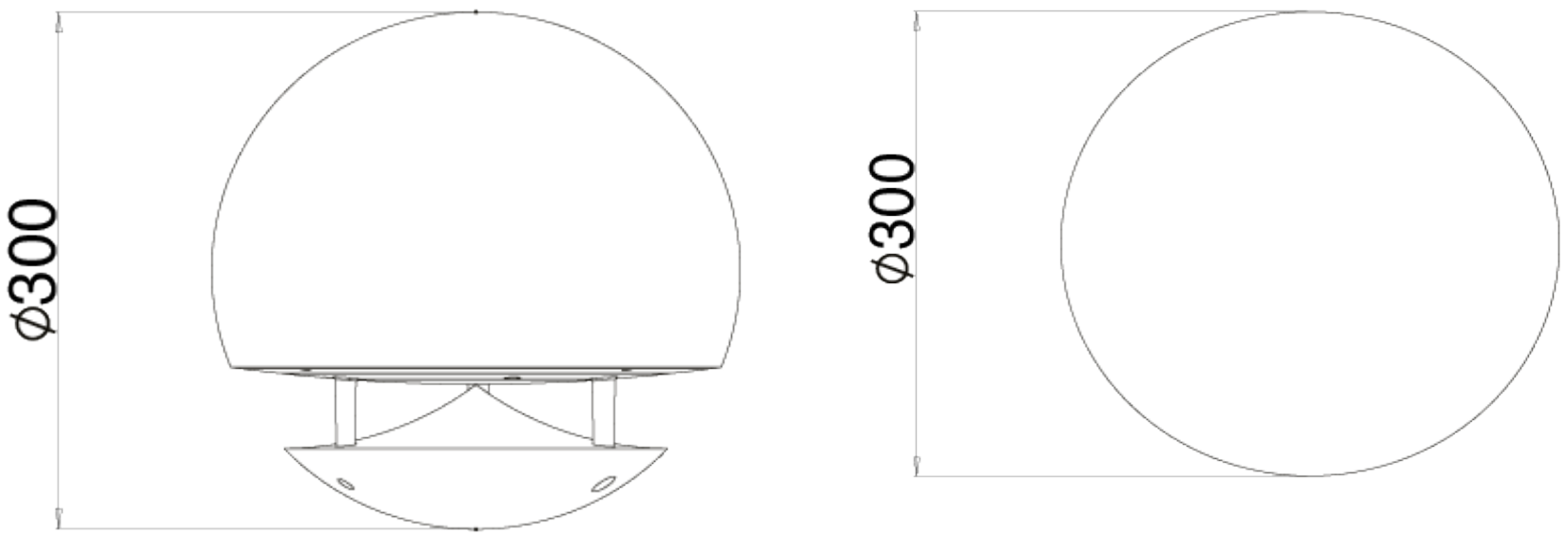
	Net Weight	15 Kg Concrete; 16.5 Kg Marble
	Shipping Weight	17 Kg Concrete; 18.5 Kg Marble
	Shipping box	40x40x40 cm; 42x79x39 cm Pair-Pack
	H.T.S. Code	85.18.21.00

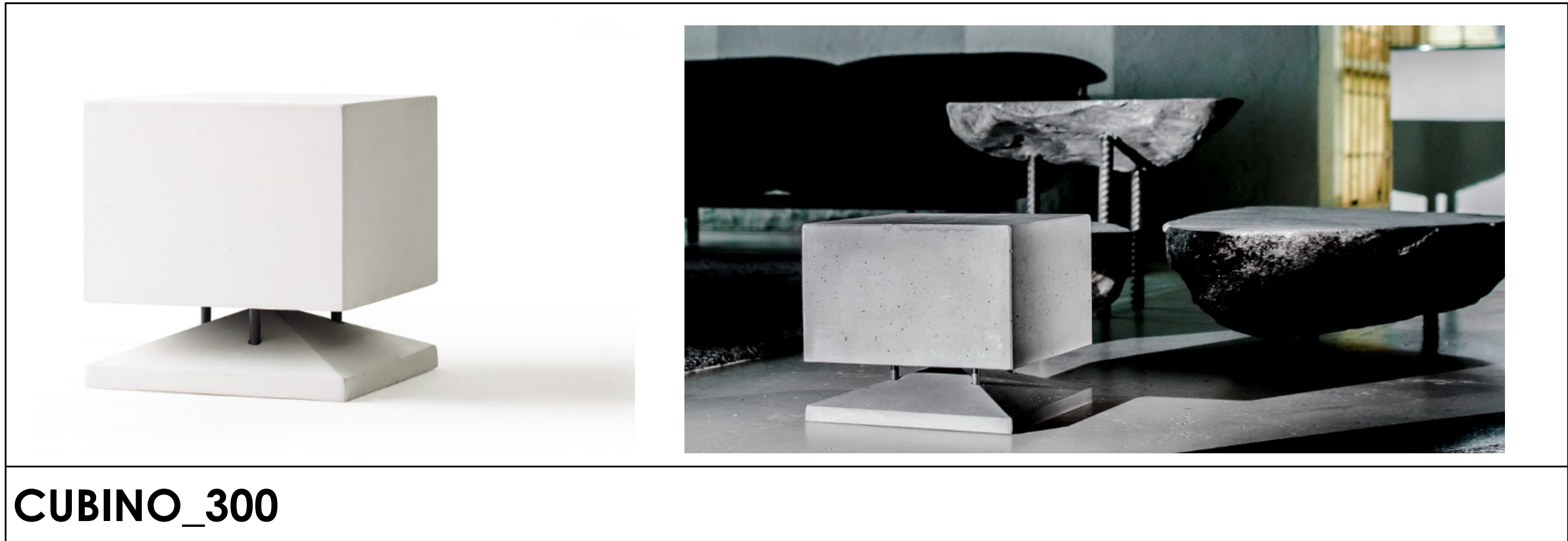

CUBINO_300

REF CODE		CHF	UVP
CB300-CN			
CB300-CNP			
CB300-CNW			
CB300-CNR			
CB300-CNB			
	<p>Cubino_Concrete Aluminium black painted legs See variations on Concrete palette at the end</p> <p> CN GREY CNP BLACK CNW WHITE CNR RED CNB OceanBlue </p>		2'190

MAIN FUNCTIONAL OPTIONS

Please note that price for all the following options has to be added to the main model price

REF CODE		CHF	UVP
CB300-XBSUB	<p>SUB VERSION WITH CROSSOVER</p>		190
CB300-HZ30	<p>HIGH IMPEDANCE ON BOARD 70/100V - 30W</p>		105
CB300-HZ60	<p>HIGH IMPEDANCE ON BOARD 70/100V - 60W</p>		140

ACCESSORIES

REF CODE		CHF	UVP
AF-CB300-VER	Anti-theft for Grass land		125
SP-CB300-VER	Sand proof system		170
COVER-CB300-B	PVC Basic Envelope		95

		Net Weight 30 Kg Shipping Weight 31 Kg Shipping Box 39.5x39.5x40 cm H.T.S. CODE 85.18.21.00
--	--	----------------------------------------------------------------------------------------------------------------------------------

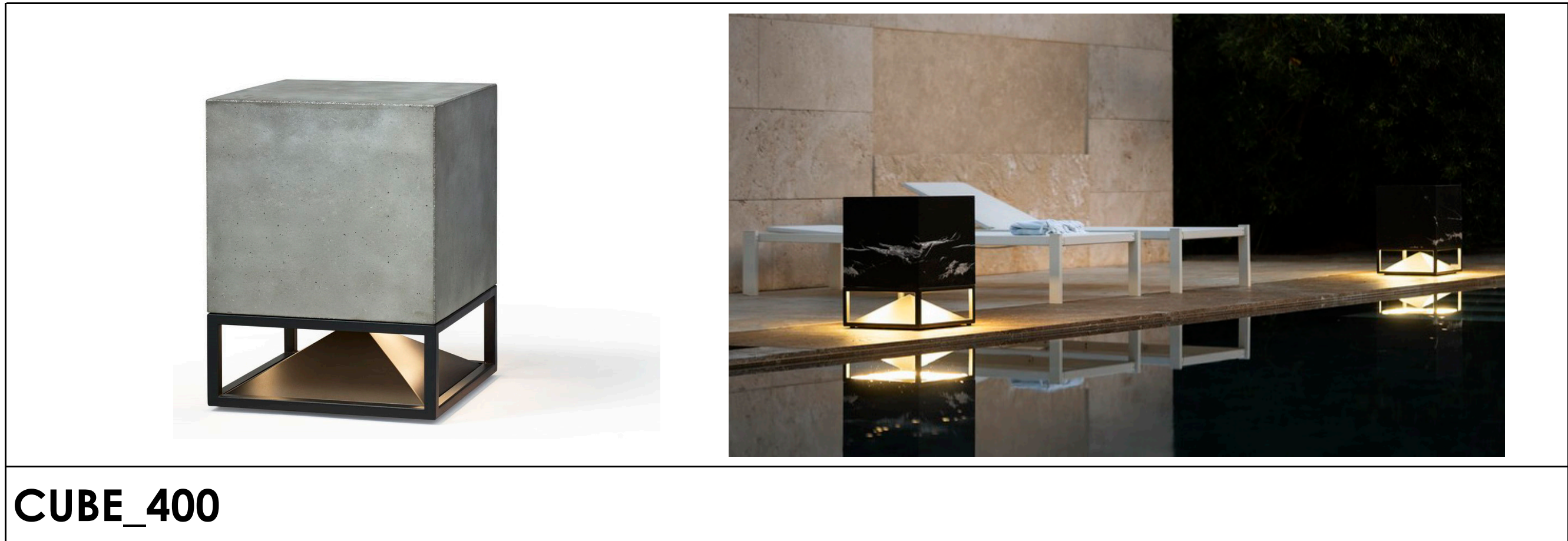





CUBE_400

REF CODE		CHF	UVP
CB400-CN CB400-CNP CB400-CNW CB400-CNR CB400-CNB	 <p>Cube 400_Concrete Steel 304 black painted base Deflector in concrete See variations on concrete palette at the end</p> <p> CN GREY CNP BLACK CNW WHITE CNR RED CNB OceanBlue </p>	 	4'150
CB400-ST01 CB400-ST02 CB400-ST03 CB400-ST04	 <p>Cube 400_Basic Stones Steel 304 black painted base (including deflector) See variations on Basic Stones palette at the end</p> <p> ST01 TRVC ST02 TRVW ST03 CARW ST04 MARQ </p>	 	6'950
CB400-PM	 <p>Cube 400_Premium Steel 304 black painted base (including deflector) See variations on premium stones palette at the end</p>	 	POR





MAIN FUNCTIONAL OPTIONS

Please note that price for all the following options has to be added to the main model price

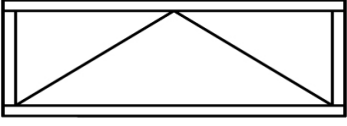

REF CODE		CHF	UVP
CB400-XSUB	 SUB VERSION WITH CROSSOVER		225
CB400-HZ30	 HIGH IMPEDANCE ON BOARD 70/100V - 30W		125
CB400-HZ60	 HIGH IMPEDANCE ON BOARD 70/100V - 60W		160
CB400-LM	 LIGHTING MOOD Led Strip in a notch around the loudspeaker area Supplied with (external) multivoltage power supply 3000 K - NO RGB		450

CUSTOMIZATION & ACCESSORIES

BASE OPTIONS FOR ALL CUBES (DEFLECTOR IN METAL)

REF CODE		CHF	UVP
CBBS-RAL	 Steel 304 Base painted in ALL RAL colors and metal deflector		520
CBBS-SAT	 SATIN Steel 316L base and metal deflector		1'470
CB-POL316	 POLISHED Steel 316L base and metal deflector		1'650
CBBS-BRS	 Oxidized BRASS base and metal deflector		1'990

BASE OPTIONS ONLY FOR CUBES IN CONCRETE (DEFLECTOR IN CONCRETE)

REF CODE		CHF	UVP
CBBS-INXCN	 SATIN Steel 316L base and concrete deflector		1'190
CBBS-BRSCN	 Oxidized BRASS base and concrete deflector		1'190



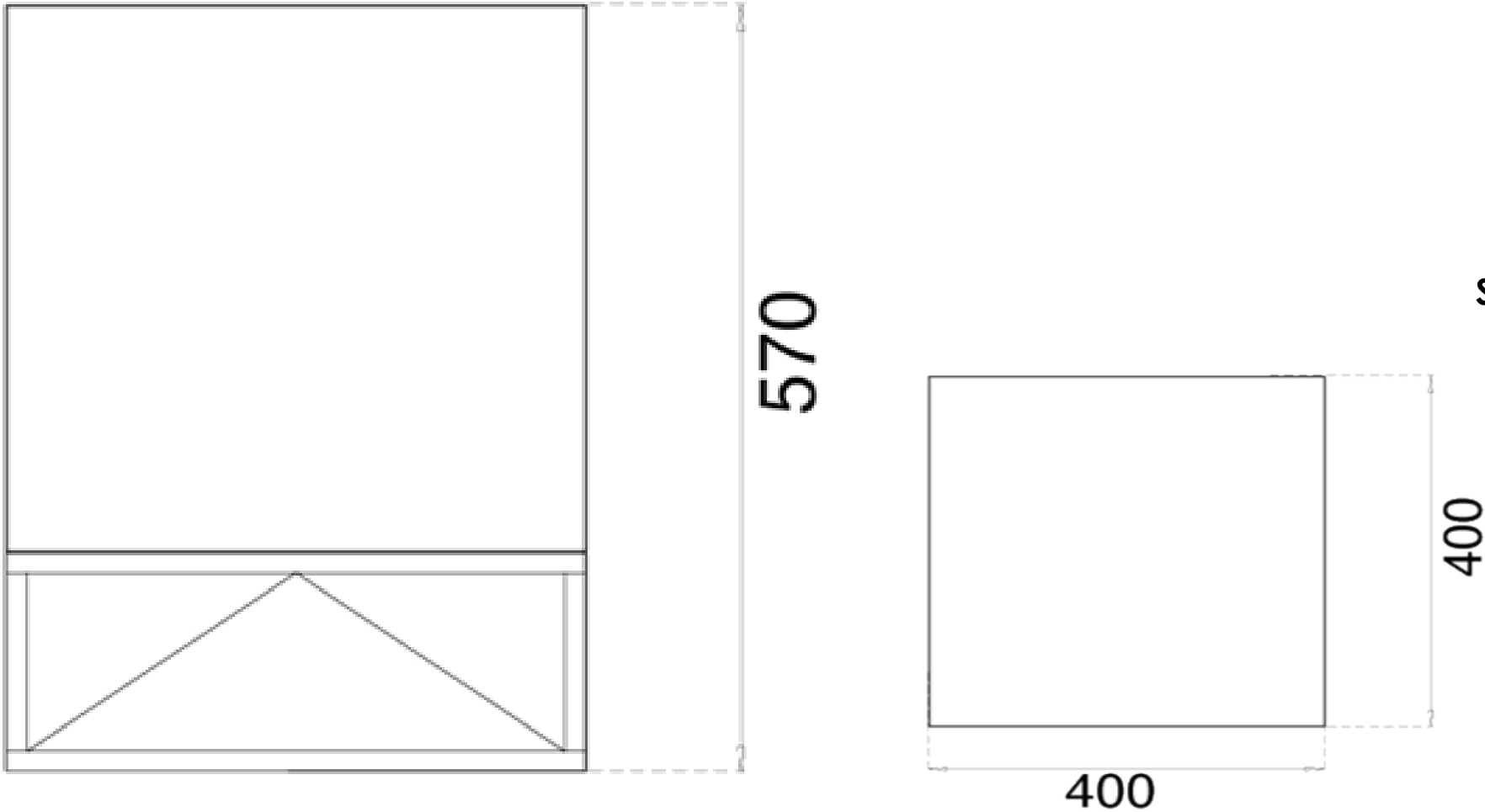

ACCESSORIES





REF CODE		CHF	UVP
PLAST400	Plaster treatment for travertines		490
POL400	Polishing treatment for all marbles		420
SP-CB400-VER	Sand proof System		170
COVER-CB400-P	PVC Premium Cover		320

	Net Weight	136 Kg Concrete; 142 Kg Marble
	Shipping Weight	138 Kg Concrete; 144 Kg Marble
	Shipping box	51x51x68 cm
	H.T.S. Code	85.18.21.00









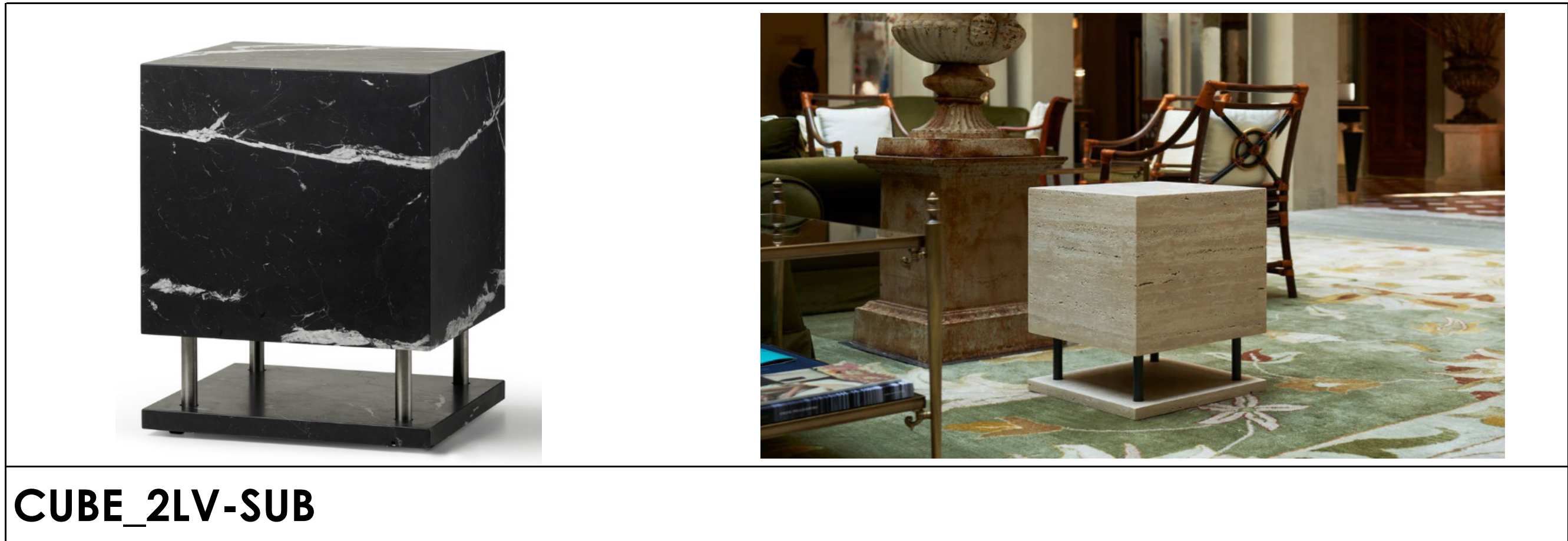

















CUBE_400-TEN

REF CODE		CHF	UVP
CB400T-CN CB400T-CNP CB400T-CNW CB400T-CNR CB400T-CNB	 <p>Cube 400_Concrete Steel 304 black painted base Deflector in concrete See variations on concrete palette at the end</p> <p> CN GREY CNP BLACK CNW WHITE CNR RED CNB OceanBlue </p>	 	2'230 3'300
CB400T-ST01 CB400T-ST02 CB400T-ST03 CB400T-ST04	 <p>Cube 400_Basic Stones Steel 304 black painted base (including deflector) See variations on Basic Stones palette at the end</p> <p> ST01 TRVC ST02 TRVW ST03 CARW ST04 MARQ </p>	 	7'350
CB400T-PM	 <p>Cube 400_Premium Steel 304 black painted base (including deflector) See variations on premium stones palette at the end</p>	 	POR

MAIN FUNCTIONAL OPTIONS			
Please note that price for all the following options has to be added to the main model price			
REF CODE		CHF	UVP
CB400T-XBSUB	 SUB VERSION WITH CROSSOVER		225
CB400T-HZ30	 HIGH IMPEDANCE ON BOARD 70/100V - 30W		125
CB400T-HZ60	 HIGH IMPEDANCE ON BOARD 70/100V - 60W		160
CB400T-LM	 LIGHTING MOOD Led Strip in a notch around the loudspeaker area Supplied with (external) multivoltage power supply 3000 K - NO RGB		450





CUBE_2LV-SUB

REF CODE		CHF	UVP
CB2LV-CN  CB2LV-CNP  CB2LV-CNW  CB2LV-CNR  CB2LV-CNB 	 <p>Cube 2LV Sub_Concrete Aluminium black painted legs See variations on Concrete palette at the end</p> <p> CN GREY  CNP BLACK  CNW WHITE  CNR RED  CNB OceanBlue  </p> 		3'590
CB2LV-ST01  CB2LV-ST02  CB2LV-ST03  CB2LV-ST04 	 <p>Cube 2LV Sub_Basic Stones Aluminium black painted legs See variations on Basic Stones palette at the end</p> <p> ST01 TRVC  ST02 TRVW  ST03 CARW  ST04 MARQ  </p> 		8'650
CB2LV-PM	 <p>Cube 2LV Sub_Premium Stones Aluminium black painted legs See variations on Premium Stones palette at the end</p> 		POR

MAIN FUNCTIONAL OPTIONS





Please note that price for all the following options has to be added to the main model price

REF CODE		CHF	UVP
CB2LV-HZ30	 HIGH IMPEDANCE ON BOARD 70/100V - 30W		105
CB2LV-HZ60	 HIGH IMPEDANCE ON BOARD 70/100V - 60W		140

CUSTOMIZATION & ACCESSORIES

Please note that price for all following options and accessories has to be added to the main model price

LEGS OPTIONS

REF CODE		CHF	UVP
2LV-LGS-INX	  Steel 316L Legs (Satin or Gunmetal finishing)		200
2LV-LGS-BRS	  Oxidized Brass Legs		280

ACCESSORIES

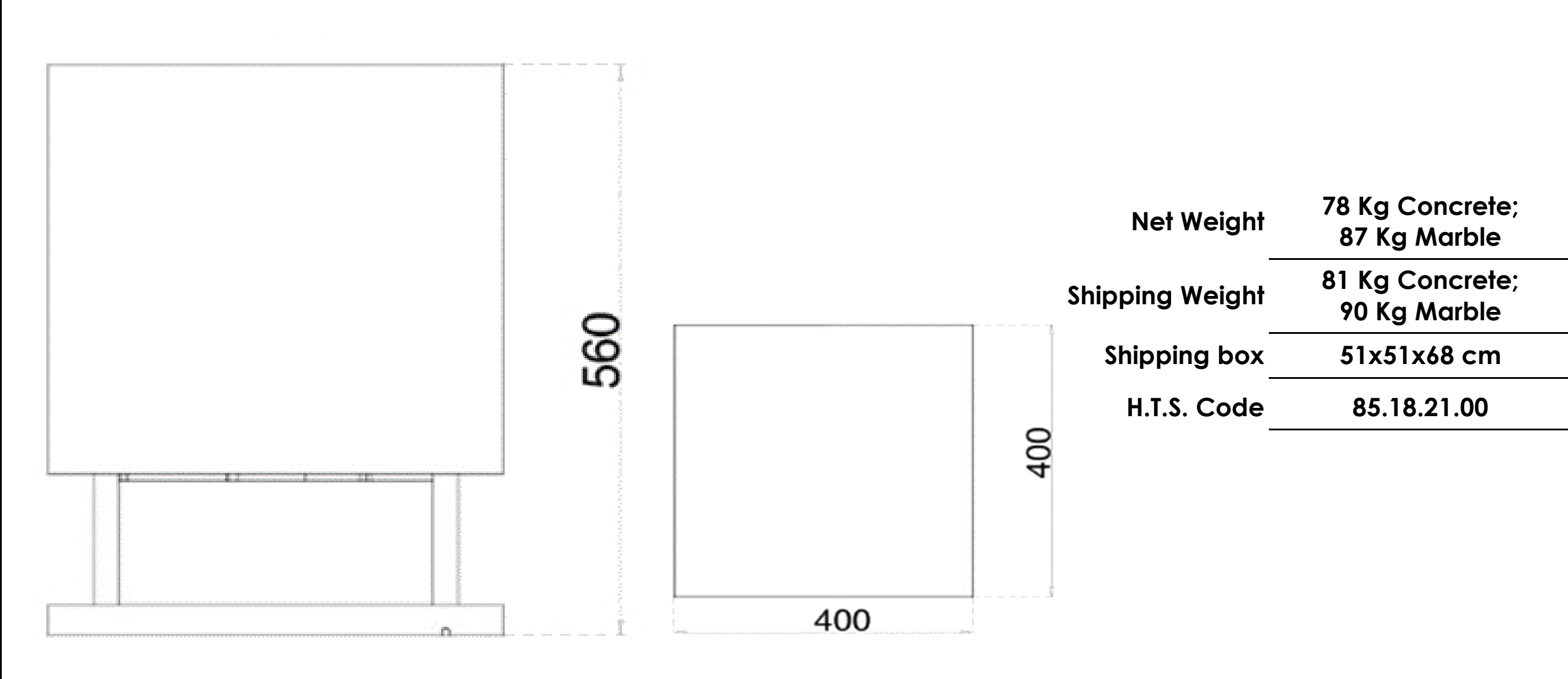

REF CODE		CHF	UVP
PLAST400-2LV	Plaster treatment for travertines		750
POL400-2LV	Polishing treatment for marbles		620



Net Weight	78 Kg Concrete; 87 Kg Marble
Shipping Weight	81 Kg Concrete; 90 Kg Marble
Shipping box	51x51x68 cm
H.T.S. Code	85.18.21.00



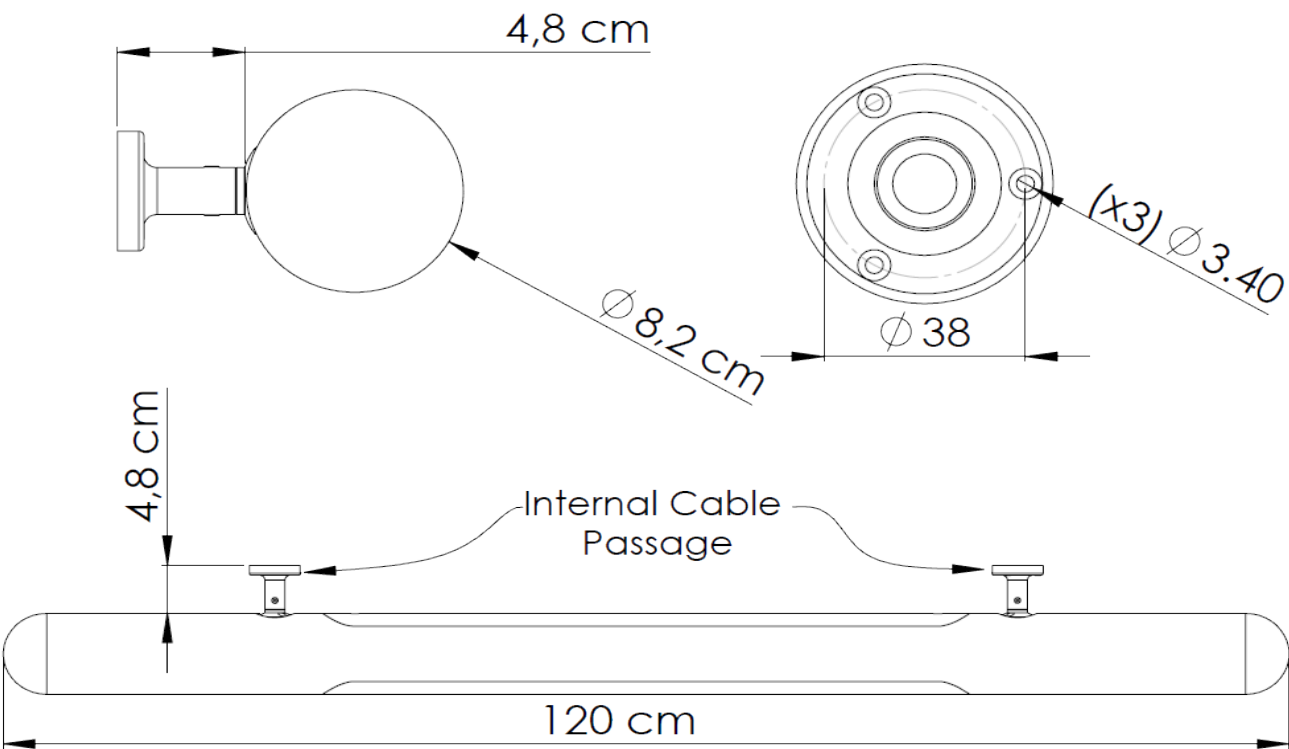
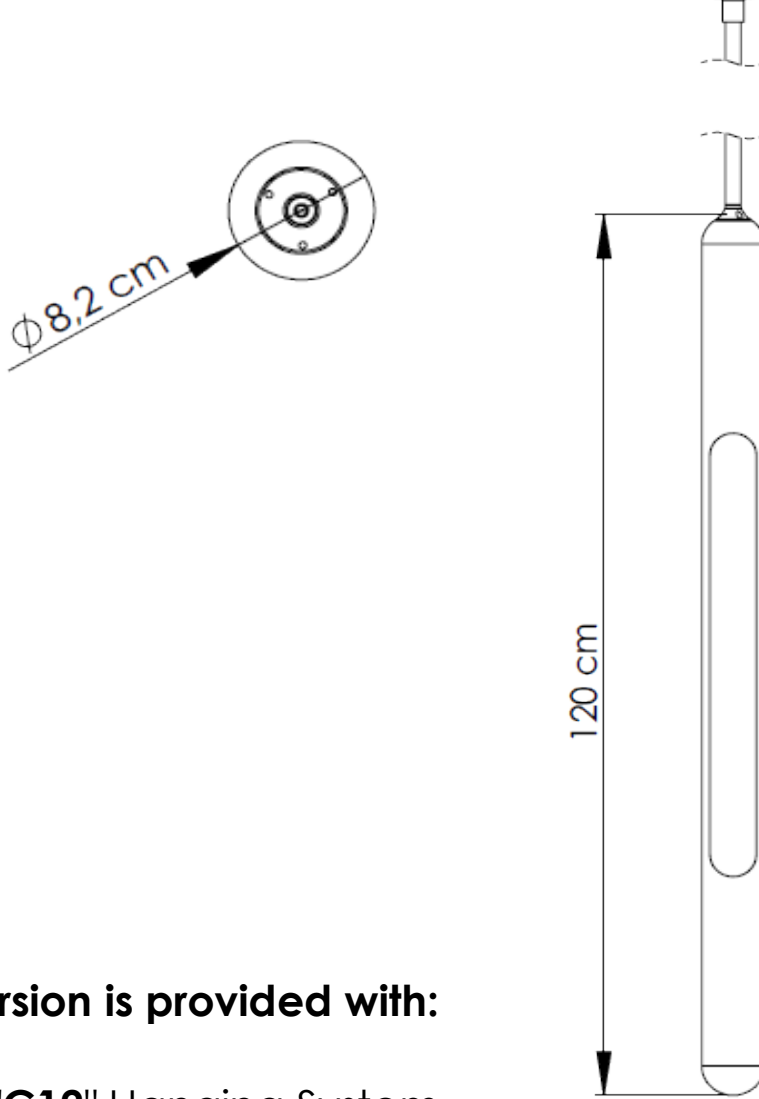

PERGOLA

REF CODE		CHF	UVP
PERGO-LA	 Pergola_Line Array Carbon Fiber <div style="display: flex; gap: 10px;"> <div style="border: 1px solid black; padding: 2px; font-size: 8px;">DSP REQUIRED</div> <div style="border: 1px solid black; padding: 2px; font-size: 8px;">SUB REQUIRED</div> </div>		6'450
PERGO-PS	 Pergola_Point Source Carbon Fiber <div style="display: flex; gap: 10px;"> <div style="border: 1px solid black; padding: 2px; font-size: 8px;">X BOARD</div> <div style="border: 1px solid black; padding: 2px; font-size: 8px;">SUB REQUIRED</div> </div>		6'450

HORIZONTAL VERSION	VERTICAL VERSION
 <p>This version is provided with:</p> <ul style="list-style-type: none"> - CROSSOVER On Board - no. 2 "X5HOR" Hanging Systems 	 <p>This version is provided with:</p> <ul style="list-style-type: none"> - no.1 "C12" Hanging System - no.1 Steel Tube (min. 10cm - max 100cm)

CUSTOMIZATION & ACCESSORIES

Please note that price for all following options and accessories has to be added to the main model price

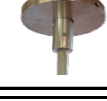
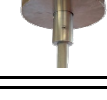

REF CODE		CHF	UVP
PERGO-PS-XE	 EXTERNAL CROSSOVER FOR HIGH SPL (in IP box) (only for Point Source version)		95
PERGO-BODY-PNT	Painting other RAL (only body, with black grid)		660
HSTD	 Standard ceiling Anchoring (2 pcs)		0
C12	 Simple ceiling Steel Hanging		95
HSM	 Ceiling vertical Iron		210
HPM	 Ceiling vertical Steel		470
SP-PERGO-VER	Sand proof Filter		280
COVER-PERGO-P	PVC Premium Cover		490

Net Weight 5 Kg
Shipping Weight 6 Kg



Shipping Box 27.5x16x15 cm
H.T.S. Code 85.18.22.00



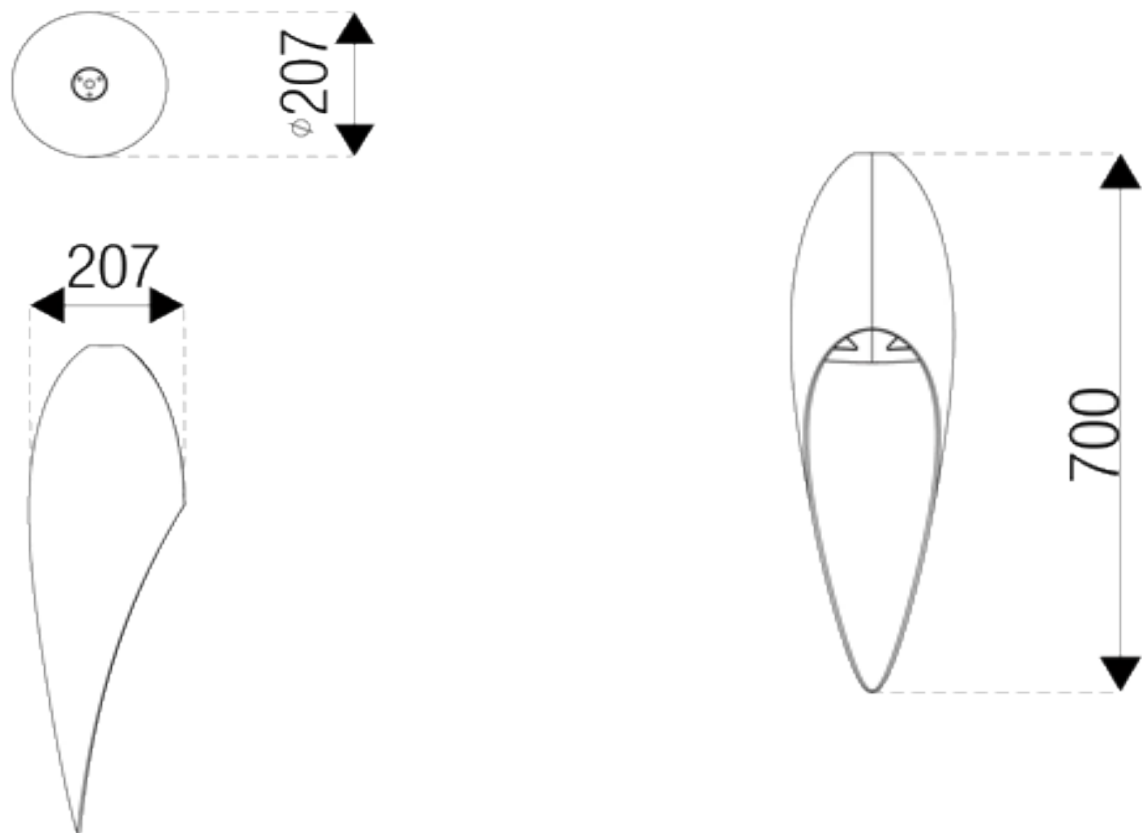

AERIAL

REF CODE		CHF	UVP
SMDRP	 <p>Small Drop Composite material (black or white) Supplied with external crossover (boxed)</p> 		5'880

	<p>Net Weight 6 Kg Gross Weight 8 Kg Shipping Box 86x32x35 cm H.T.S. Code 85.18.21.00</p>
--------------------------------------------------------------------------------------	-----------------------------------------------------------------------------------------------------------------------------------

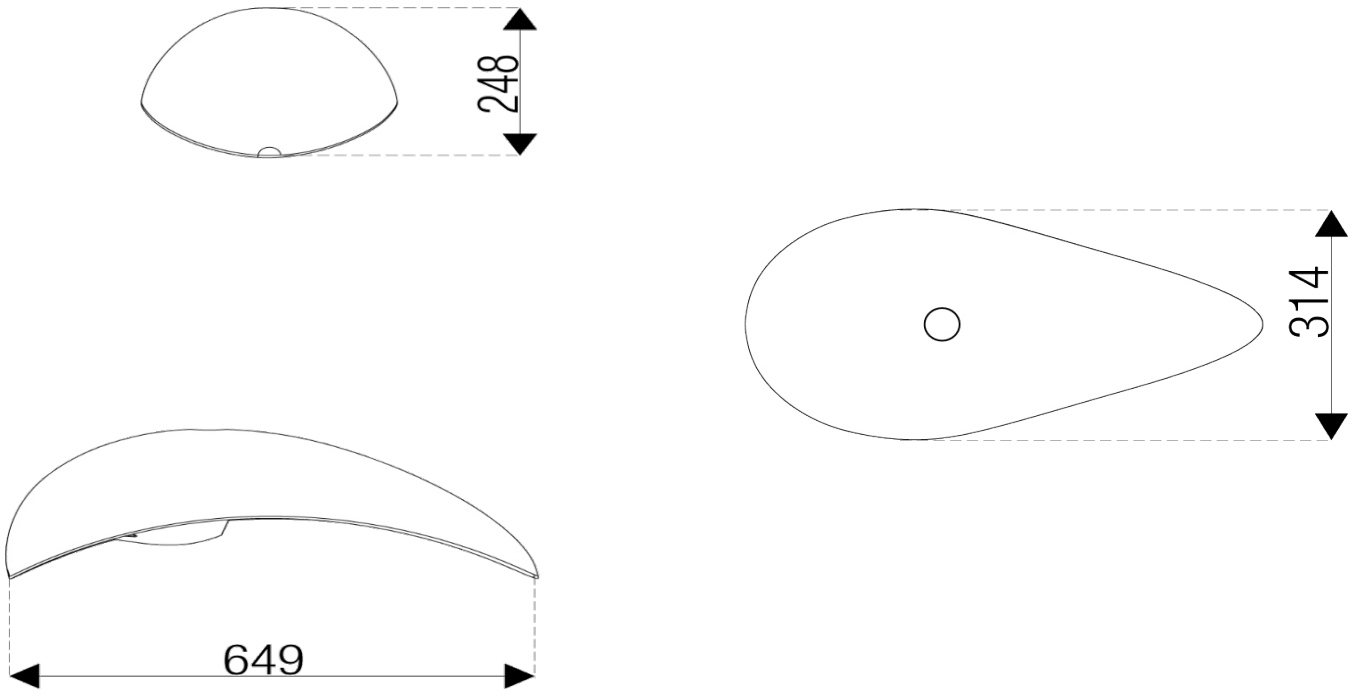

REF CODE		CHF	UVP
SMHLM	 <p>Small Helmet Composite material (black or white) Supplied with external crossover (boxed)</p> 		5'290

	<p>Net Weight 6 Kg Gross Weight 8 Kg Shipping Box 78x41x41 cm H.T.S. Code 85.18.21.00</p>
--------------------------------------------------------------------------------------	-----------------------------------------------------------------------------------------------------------------------------------

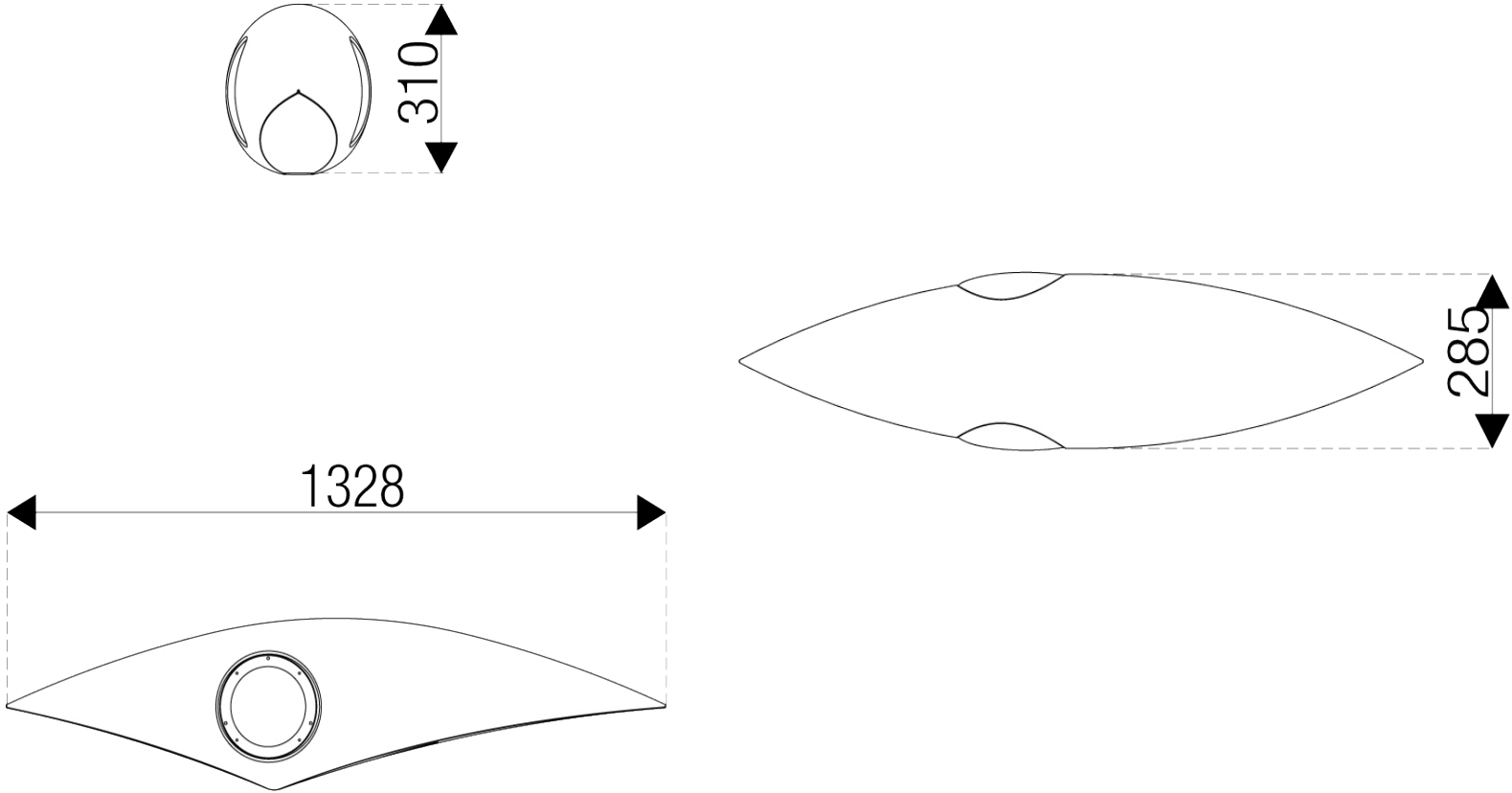
REF CODE			CHF	UVP
SHRK		Shark_Sub Composite material (black or white) No crossover on board (passive)		6'390



Net Weight 13 Kg
Gross Weight 15 Kg
Shipping Box 145x35x45 cm
H.T.S. Code 85.18.21.00

REF CODE			CHF	UVP
DROP		Drop Composite material (black or white)		7'290

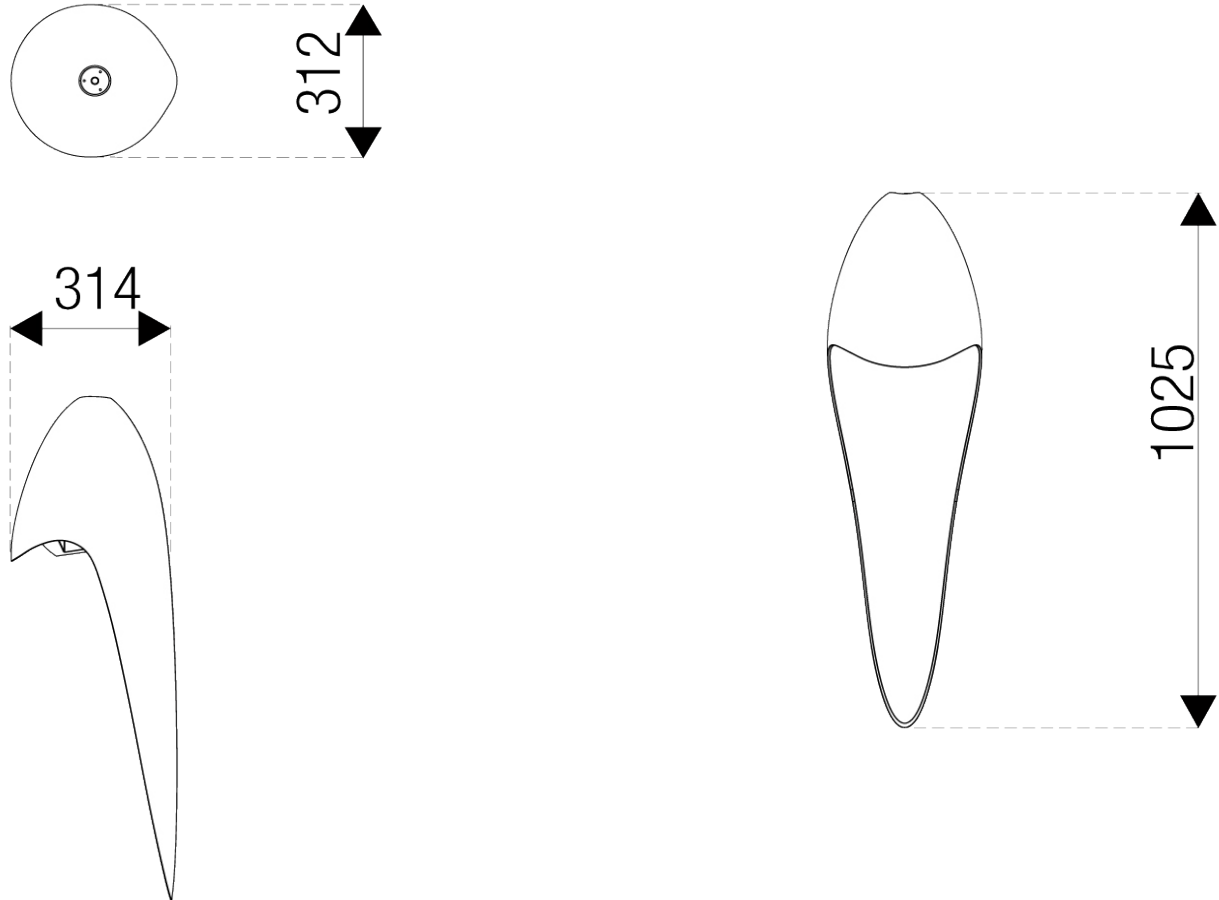







Net Weight 8 Kg
Gross Weight 10 Kg
Shipping Box 127x35x40 cm
H.T.S. Code 85.18.21.00

CUSTOMIZATION & ACCESSORIES

Please note that price for all following options and accessories has to be added to the main model price

HANGING TUBE SYSTEMS

REF CODE		CHF	UVP
HSTD	 Simple Hangings (Aluminium) F12; FK12; K12		110
C12	 Simple Ceiling Stainless Steel Hanging		100
HSM	 Iron Hanging not orientable		225
HPM	 Steel Hanging not orientable		495
H45D	 Orientable 45 Steel Hanging		495
H90D	 Orientable 90 Steel Hanging		650
HWSP	 Widening Plate for orientable hanging		75

ACCESSORIES

REF CODE		CHF	UVP
SUSP-RAL	Painting others RAL		POR
SP-SUSP-VER	Sand proof System*		260
COVER-PS	PVC Premium Cover small (for Small Drop/S. Helmet)		540
COVER-PL	PVC Premium Cover large (for Shark/Drop)		720

*Not available for Shark



AS AMPLIFIERS_ Master Volume
Ice Power Technology



AS AMPLIFIERS_ Master Volume

Ice Power Technology - fitted with table top mounting accessories, rack mounting kit included

REF CODE		CHF	UVP
ASM2EVO	AS-M2EVO 2 ch x 1000W @4Ω Proprietary Audio processor		2'500



POWERSOFT AMPLIFIERS

REF CODE		CHF	UVP
PS2404DSP	QUATTROCANALI 2404 DSP+D 4x600W Amplifier Platform (@4Ω and @8Ω) with DSP (Armonia Plus) and Dante™		3'650
PS2404	QUATTROCANALI 2404 4x600W Amplifier Platform (@4Ω and @8Ω)		2'990
PS1204DSP	QUATTROCANALI 1204 DSP+D 4x300W Amplifier Platform (@4Ω and @8Ω) with DSP (Armonia Plus) and Dante™		2'290
PS1204	QUATTROCANALI 1204 4x300W Amplifier Platform (@4Ω and @8Ω)		2'290
PSMEZ322	MEZZO 322 A 2x160W Amplifier Platform (@4Ω and @8Ω) with DSP (Armonia Basic)		1'190
PSMEA602	MEZZO 602 A 2x300W (@4Ω and @8Ω) with DSP (Armonia Basic)		1'390
PSMEZ324	MEZZO 324 A 4x80W (@4Ω and @8Ω) with DSP (Armonia Basic)		1'390
PSMEZ604	MEZZO 604 A 4x150W (@4Ω and @8Ω) with DSP (Armonia Basic)		1'750

A.S. PROMO KITS



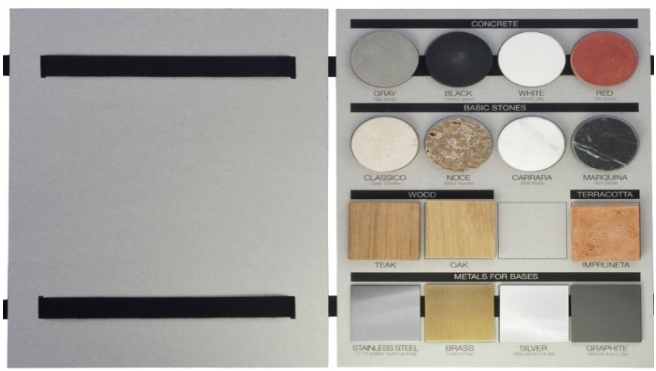

SAMPLE KITS

REF CODE		CHF	UVP
ASKIT-BASIC		<p>AS Basic Sample Kit</p> <p>This Basic Sample Kit folder is the most practical tool to show the variety and quality of finishings of the A.S. materials</p>	200
ASKIT-PM		<p>AS Premium Sample Kit</p> <p>This elegant A.S. wooden Premium Sample Kit box is the the best tool to hold a range of our exclusive stones, concretes, wood and metals in your hand and get a feel of the various qualities and surface finishes.</p>	590

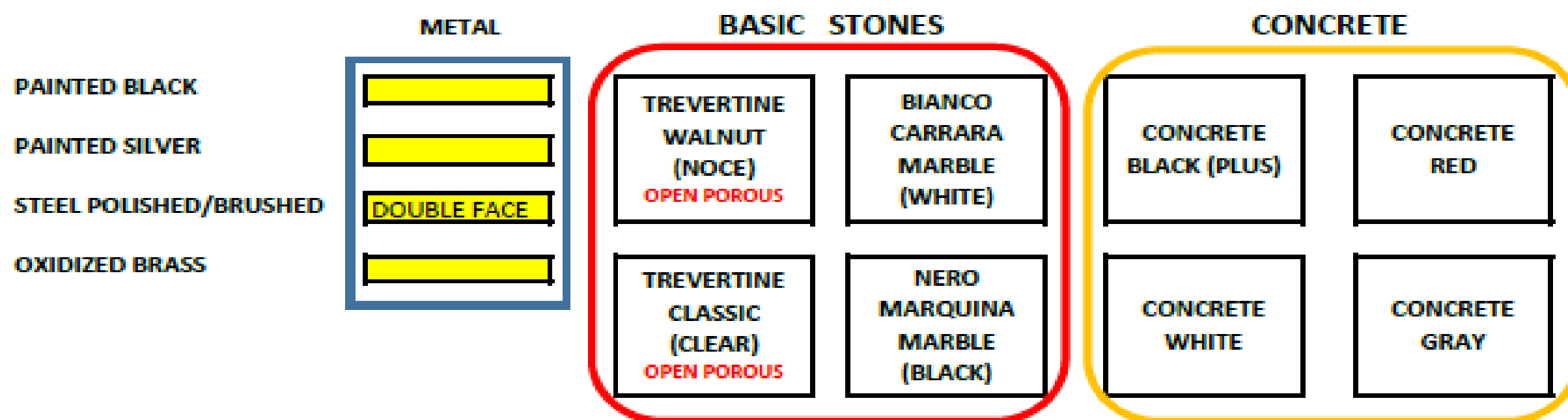
PREMIUM SAMPLE KIT

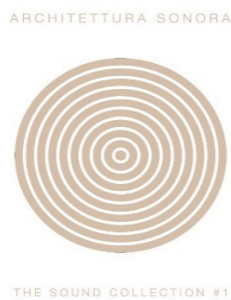

CATALOGUES & LEAFLETS

REF CODE		CHF	UVP
AS-CAT22	 <p>no.10 "THE SOUND COLLECTION #1" AS_Catalogue 2022 edition Architettura Sonora's Full Catalogue including Product Datasheets (A4 - 144 pages)</p>		100
AS-LEAF22	 <p>no.30 "THE SOUND OVERVIEW #1" AS_Leaflet 2022 edition Architettura Sonora's Leaflet (A4 - 14 pages)</p>		35

T-SHIRTS & BAGS

REF CODE		CHF	UVP
AS-TSHIRT	 <p>no.5 AS T-Shirt Short Sleeve T-Shirt 100% Black Cotton (Sizes M - L - XL)</p>		75
AS-BAG	 <p>no.10 AS BAG_KNAPSACK Organic Cotton backpack (135 grams) with AS logo screen printing</p>		75